

ROTEL

Owner's Manual

RSX-1065 Surround Sound Receiver

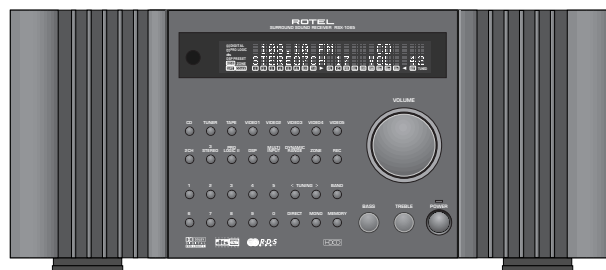

CAUTION

RISK OF ELECTRIC SHOCK

DO NOT OPEN

CAUTION: TO REDUCE THE RISK OF ELECTRIC SHOCK, DO NOT REMOVE COVER. NO USER-SERVICEABLE PARTS INSIDE. REFER SERVICING TO QUALIFIED SERVICE PERSONNEL.

APPLICABLE FOR USA, CANADA OR WHERE APPROVED FOR THE USAGE

CAUTION: TO PREVENT ELECTRIC SHOCK, MATCH WIDE BLADE OF PLUG TO WIDE SLOT. INSERT FULLY.

ATTENTION: POUR EVITER LES CHOCES ELECTRIQUES, INTRODUIRE LA LAME LA PLUS LARGE DE LA FICHE DANS LA BORNE CORRESPONDANTE DE LA PRISE ET POUSSER JUSQU'AU FOND.

This symbol is to alert the user to the presence of un-insulated dangerous voltages inside the product's enclosure that may constitute a risk of electric shock.

This symbol is to alert the user to important operating and maintenance (service) instructions in this manual and literature accompanying the product.



ANTENNA GROUNDING ACCORDING TO NATIONAL ELECTRICAL CODE INSTRUCTIONS ARTICLE 810: "RADIO AND TELEVISION EQUIPMENT"

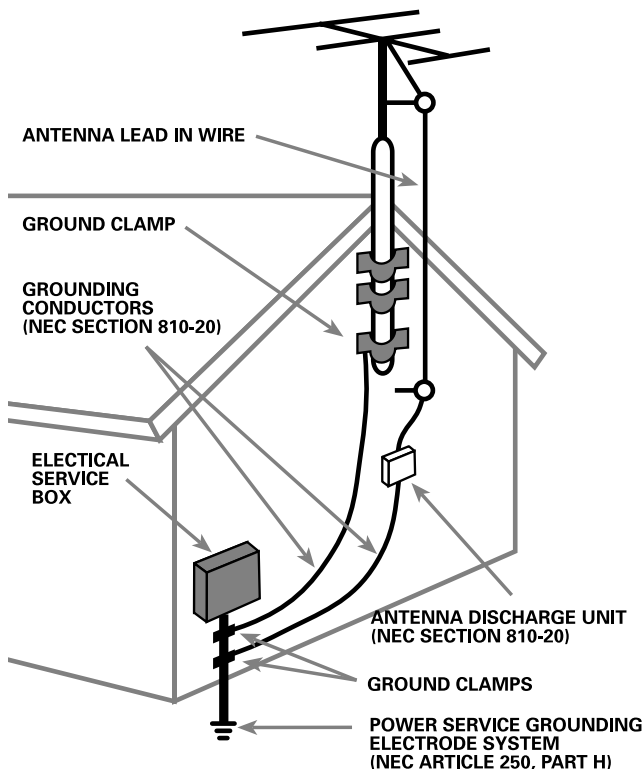

Important Safety Instructions

WARNING: There are no user serviceable parts inside. Refer all servicing to qualified service personnel.

WARNING: To reduce the risk of fire or electric shock, do not expose the unit to moisture or water. Do not allow foreign objects to get into the enclosure. If the unit is exposed to moisture, or a foreign object gets into the enclosure, immediately disconnect the power cord from the wall. Take the unit to a qualified service person for inspection and necessary repairs.

Read all the instructions before connecting or operating the component. Keep this manual so you can refer to these safety instructions.

Heed all warnings and safety information in these instructions and on the product itself. Follow all operating instructions.

Clean the enclosure only with a dry cloth or a vacuum cleaner.

You must allow 10 cm or 4 inches of unobstructed clearance around the unit. Do not place the unit on a bed, sofa, rug, or similar surface that could block the ventilation openings. If the unit is placed in a bookcase or cabinet, there must be ventilation of the cabinet to allow proper cooling.

Keep the component away from radiators, heat registers, stoves, or any other appliance that produces heat.

The unit must be connected to a power supply only of the type and voltage specified on the rear panel. (USA: 115 V/60Hz, EC: 230V/50Hz)

Connect the component to the power outlet only with the supplied power supply cable or an exact equivalent. Do not modify the supplied cable. Do not defeat grounding and/or polarization provisions. The cable should be connected to a 2-pin polarized wall outlet, matching the wide blade of the plug to the wide slot of the receptacle. Do not use extension cords.

Do not route the power cord where it will be crushed, pinched, bent, exposed to heat, or damaged in any way. Pay particular attention to the power cord at the plug and where it exits the back of the unit.

The power cord should be unplugged from the wall outlet if the unit is to be left unused for a long period of time.

Immediately stop using the component and have it inspected and/or serviced by a qualified service agency if:

- The power supply cord or plug has been damaged.
- Objects have fallen or liquid has been spilled into the unit.
- The unit has been exposed to rain.
- The unit shows signs of improper operation
- The unit has been dropped or damaged in any way

NOTE TO CATV SYSTEM INSTALLER: Call the CATV system or antenna installer's attention to Article 820-40 of the NEC. This provides guidelines for proper grounding and, in particular, specifies that the cable ground shall be connected to the grounding system of the building, as close to the point of cable entry as practical. See installation diagram.

NOTE: This equipment has been tested and found to comply with the limits for a Class B digital device, pursuant to Part 15 of the FCC Rules. These limits are designed to provide reasonable protection against interference in a residential installation. This equipment generates and can radiate radio frequency energy and, if not installed and used in accordance with the instructions, may cause interference to radio or TV communications. There is no guarantee that interference will not occur in a particular installation. If this equipment does cause interference to radio or television reception, which can be determined by turning the equipment off and on, try to correct the interference by one or more of the following measures:

- Reorient or relocate the receiving antenna.
- Increase the separation between the unit and the television tuner.
- Connect the unit to an AC power outlet on a different electrical circuit.
- Consult your authorized Rotel retailer for assistance.

1: Controls and Connections

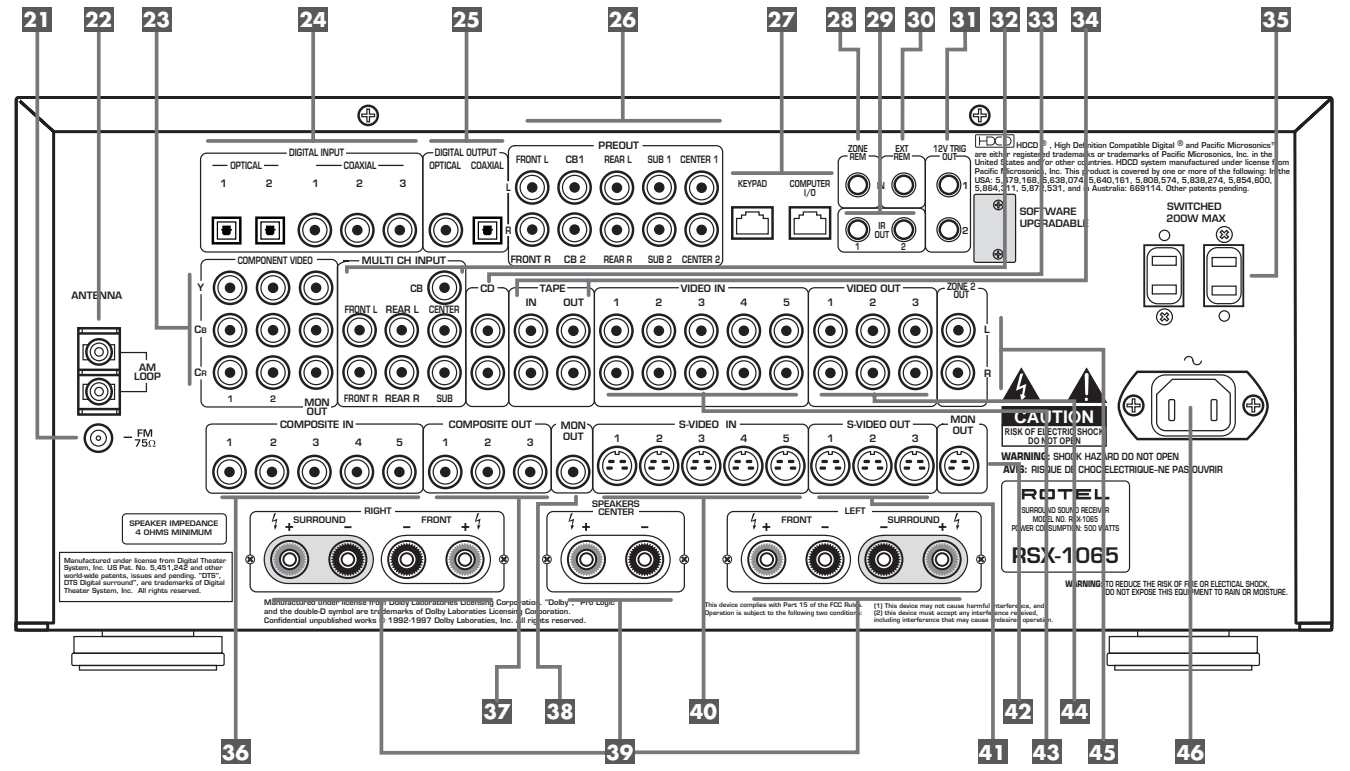
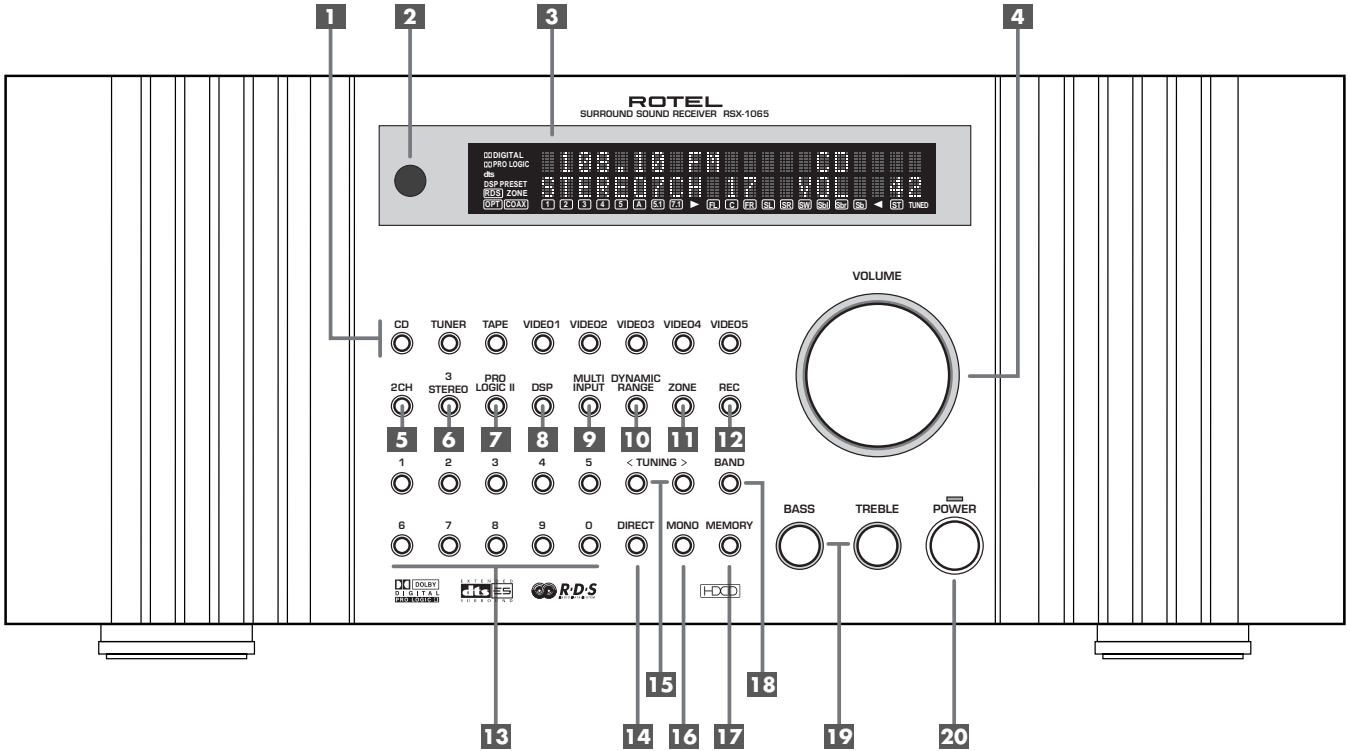

2: FL Display

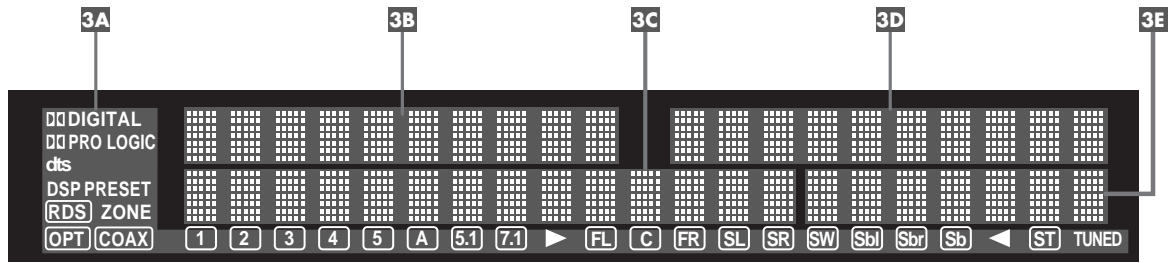

3: RR-969 Remote

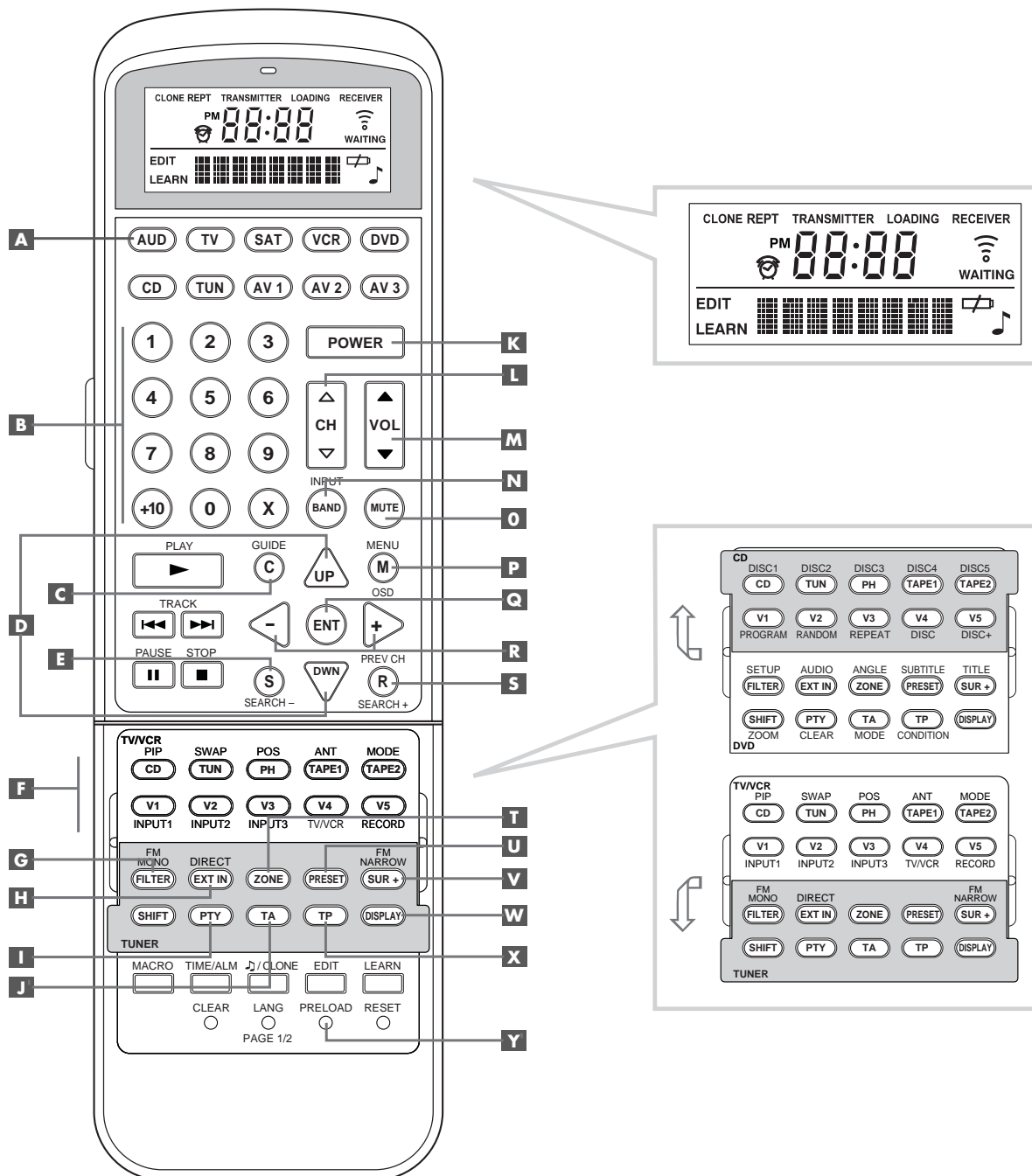

4: Outputs

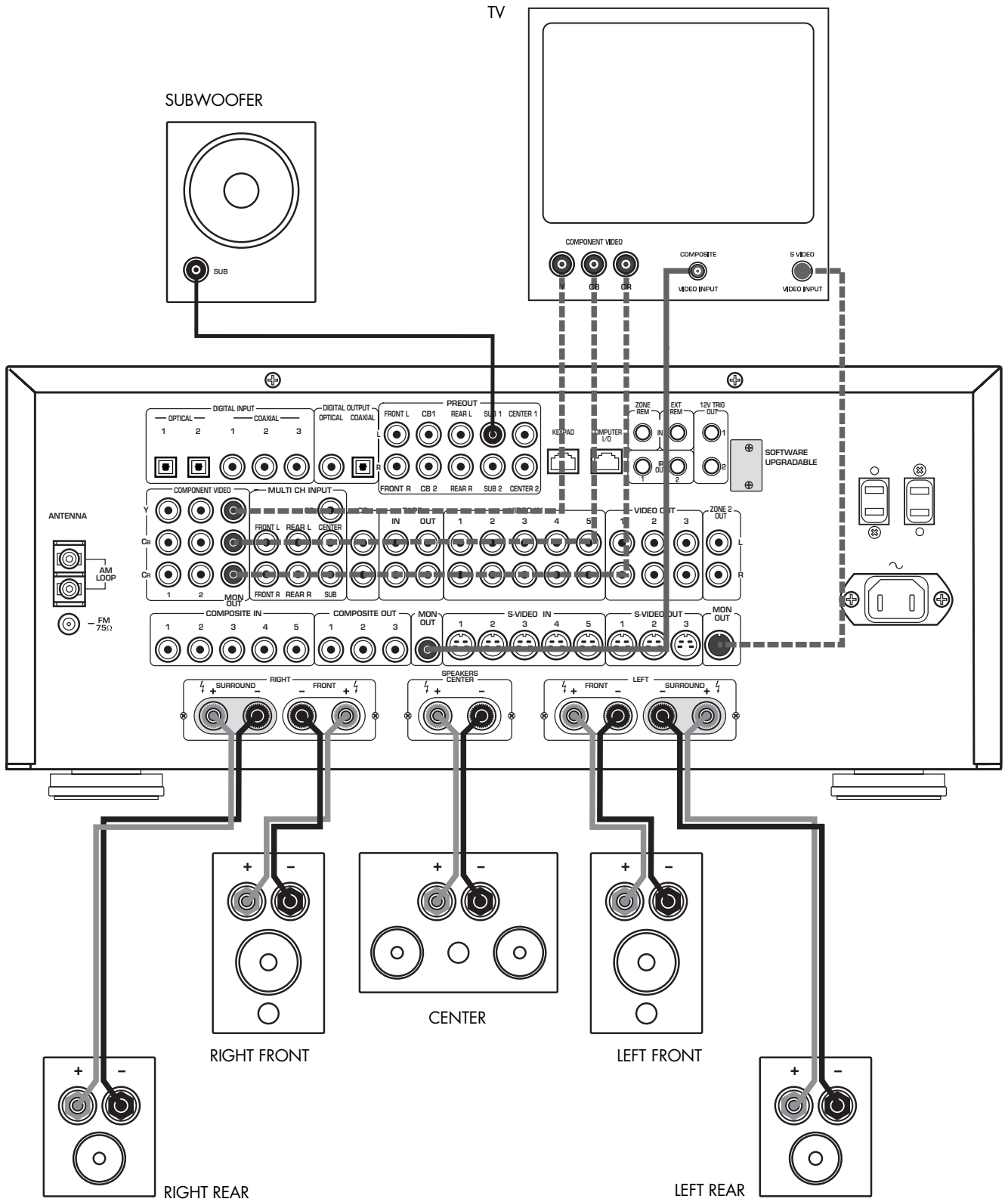

6: Video Inputs

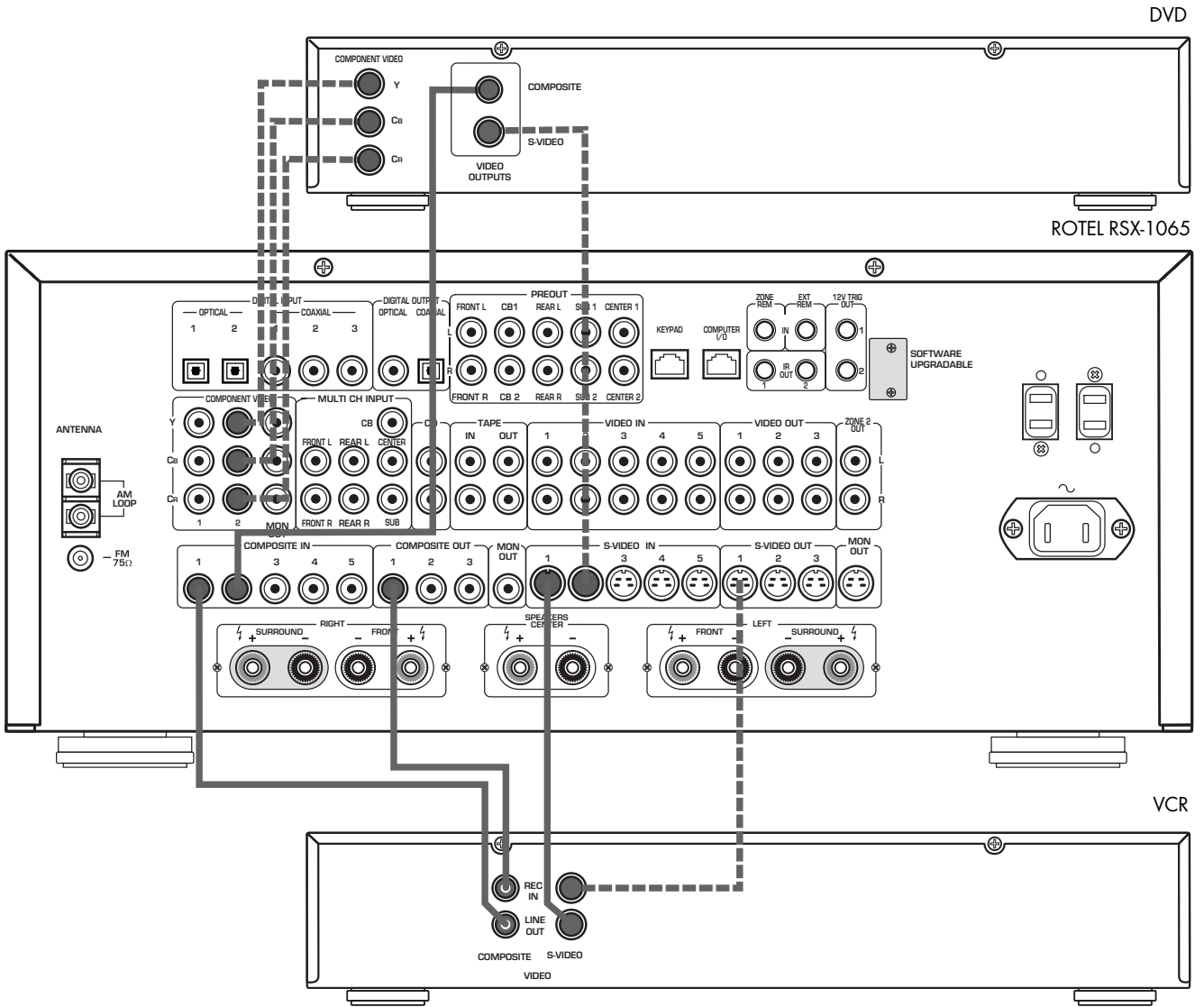

7: Zone 2 Connections

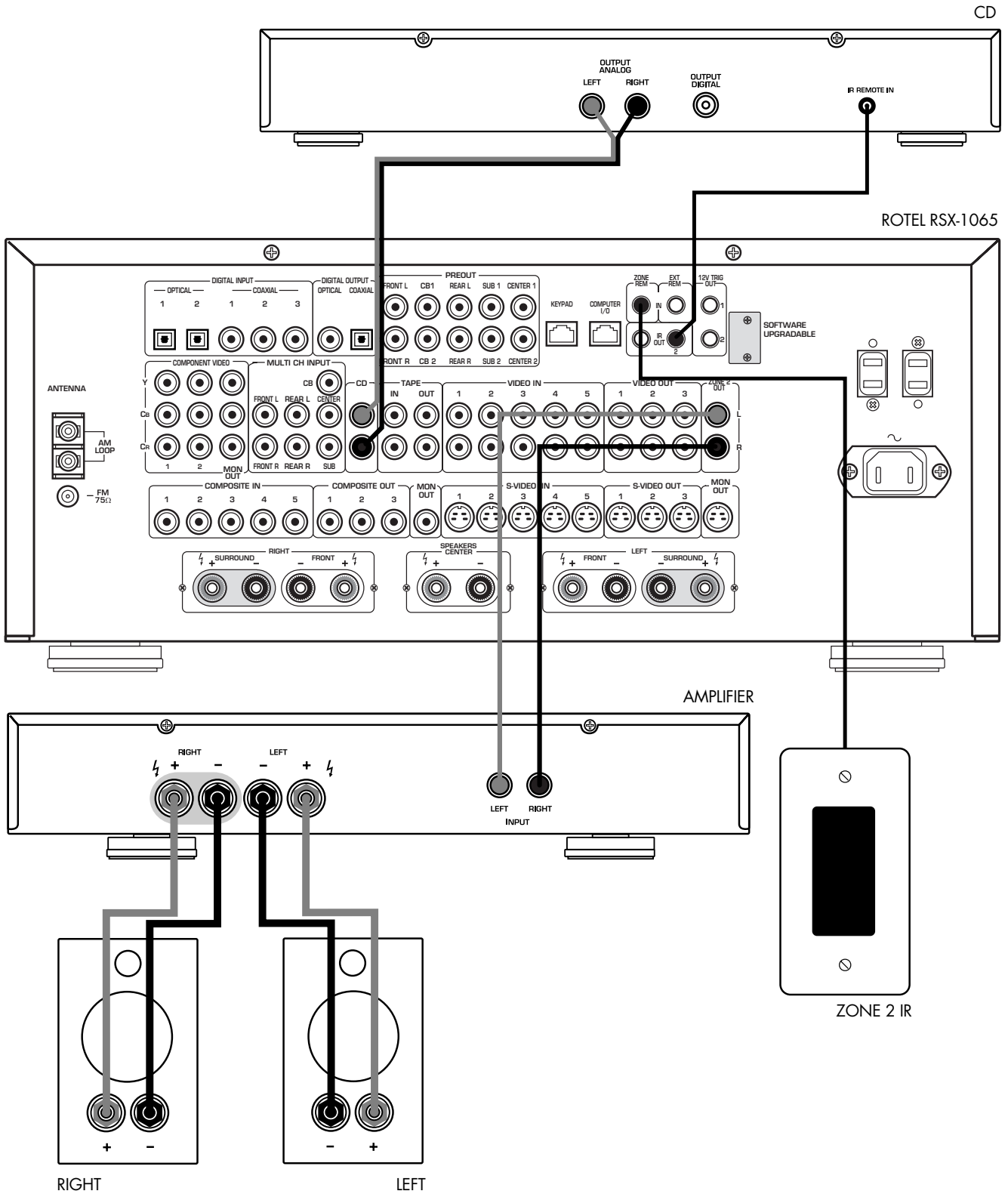

8: Antenna

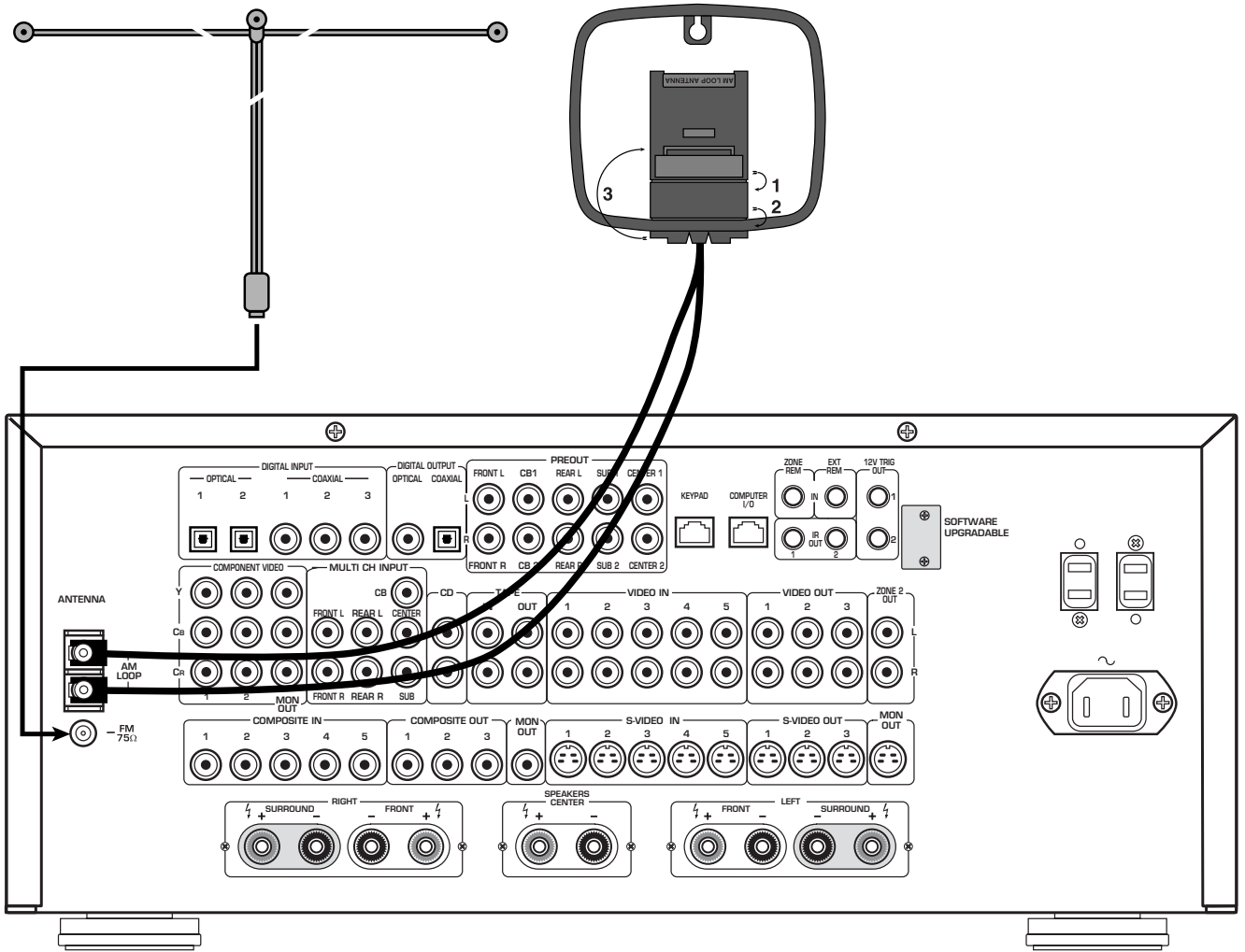

8: On-Screen Display Menus

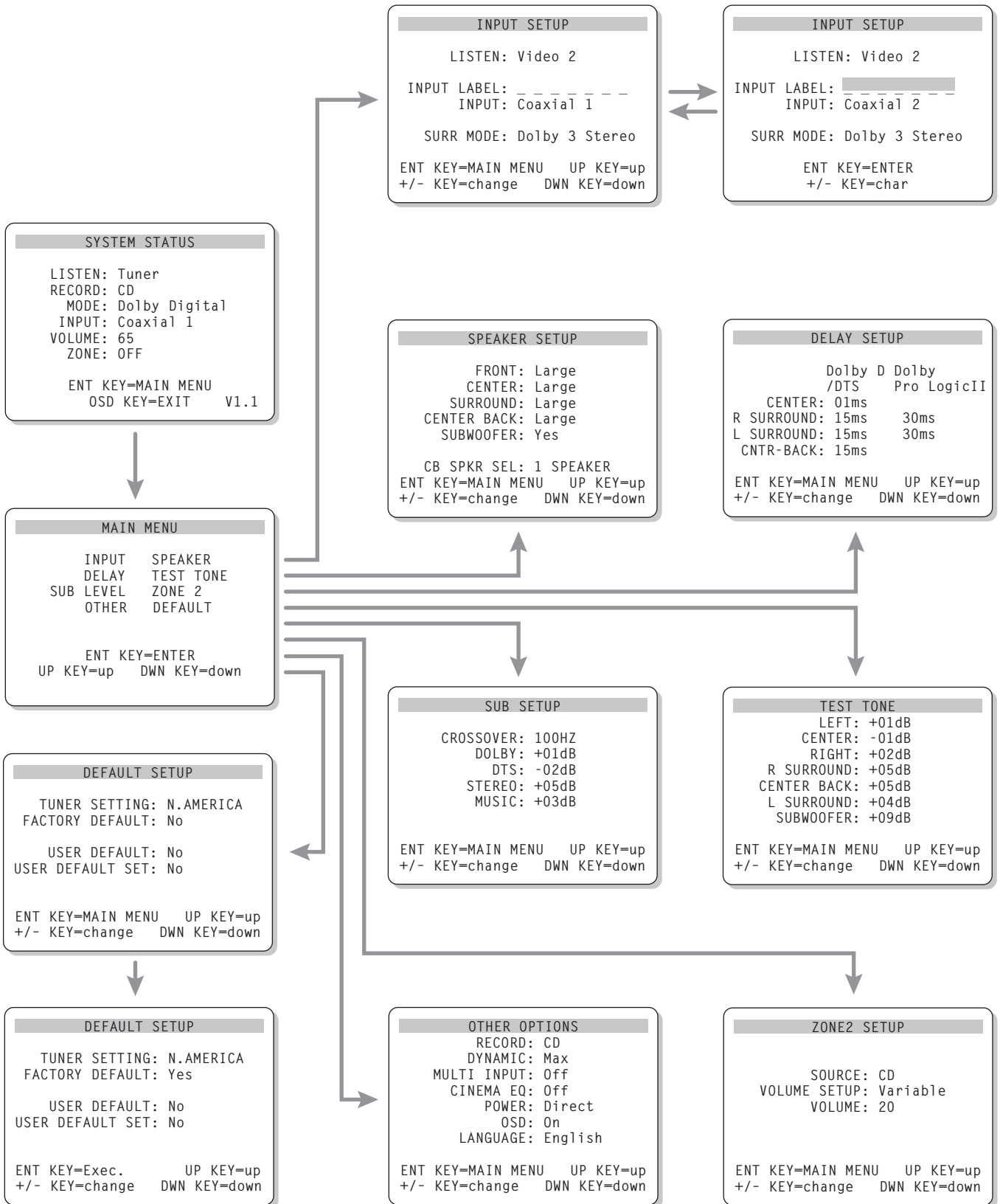

Contents

Boxed numbers refer to RSX-1065 illustration.
Boxed letters refer to RR-969 illustration.

1: Controls and Connections	3	Surround Sound Controls	15	Digital Source Connections	21
2: FL Display	4	PRO LOGIC II Button 7	15	Digital Inputs 24	21
3: RR-969 Remote	4	3 STEREO Button 6	15	Digital Outputs 25	21
4: Outputs	5	DSP Button 8	15	Output Signal Connections	21
5: Audio Inputs	6	2CH Button 5	15	TV Monitor Output 23 38 42	21
6: Video Inputs	7	SUR+ Button V	16	Speaker Outputs 39	21
7: Zone 2 Connections	8	Speaker Level Adjustment		RCA Preamp Outputs 26	22
8: Antenna	9	Selection Buttons C E S		Antenna Connections	22
8: On-Screen Display Menus	10	UP/DOWN Buttons D	16	AM Loop Antenna 22	22
		DYNAMIC RANGE Button 10		FM Wire Antenna 21	22
		DWN Button D	16	Power and Miscellaneous Connections ...	22
About Rotel	12	Tuner Controls	16	AC Input 46	22
Getting Started	12	BAND Button 18 N	17	Accessory Power Outlets 35	
Key Features	12	TUNING Buttons 15 L	17	(North American version)	22
Unpacking	12	MEMORY Button 17	17	12V TRIGGER Connections 31	22
Placement	12	NUMERIC Buttons:		EXTERNAL REM IN 30	23
		Station Presets 13 B	17	Computer I/O	
RR-969 Remote Control	13	DIRECT Button 14	17	Keypad 27	23
Using the RR-969 A	13	MONO Button 16	17	Zone 2 Connection and Operation	23
Programming the RR-969 Y	13	PRESET Button U	17	Zone 2 Power On/Off Operation	23
Basic Controls	13	RDS and RBDS Broadcast Reception	18	Controlling Zone 2	
POWER Switch 20 K	13	DISPLAY Button W	18	from the Main Room	
Remote Sensor 2	13	PTY Button I	18	ZONE Button 11	23
Front-panel Display 3	13	TP Button X	18	Controlling Zone 2 from the Remote Location ...	24
Volume Control 4 M	13	TA Button J	18	Zone 2 Audio Outputs 45	24
MUTE Button O	14	Connections: Overview	19	ZONE REM IN Jack 28	24
Tone Controls 19	14	Video Connections	19	IR OUT Jacks 29	24
FILTER Button G	14	Audio Source Connections	19	On-Screen Display / Configuration	25
MENU Button P	14	CD Inputs 33	19	Navigation Buttons D P Q R	25
ENTER Button Q	14	TAPE Inputs and Outputs 34	19	SYSTEM STATUS Menu	25
Input Controls	14	Video Source Inputs	20	MAIN Menu	25
Input Source Buttons 1 F	14	VIDEO 1–5 Audio Inputs 43	20	INPUT Menu	26
REC Button 12		VIDEO 1–5		SPEAKER SETUP Menu	26
ZONE Button T	14	Composite Video Inputs 36	20	DELAY SETUP Menu	27
MULTI Input 9		VIDEO 1–5 S-Video Inputs 40	20	SUBWOOFER SETUP Menu	28
EXT IN H	14	VIDEO 1–2		TEST TONE Menu	28
		Component Video Inputs 23	20	OTHER OPTIONS Menu	28
		MULTI Channel Audio Inputs 32	20	DEFAULT SETUP Menu	29
		Video Source Outputs	20	ZONE 2 SETUP Menu	30
		VIDEO 1–3 Audio Outputs 44	21	Specifications	30
		VIDEO 1–3			
		Composite Video Outputs 37	21		
		VIDEO 1–3 S-Video Outputs 41	21		

About Rotel

A family whose passionate interest in music led them to manufacture high fidelity components of uncompromising quality founded Rotel 40 years ago. Through the years that passion has remained undiminished and the family goal of providing exceptional value for audiophiles and music lovers regardless of their budget, is shared by all Rotel employees.

The engineers work as a close team, listening to, and fine tuning each new product until it reaches their exacting musical standards. They are free to choose components from around the world in order to make that product the best they can. You are likely to find capacitors from the United Kingdom and Germany, semi conductors from Japan or the United States, while toroidal power transformers are manufactured in Rotel's own factory.

Rotel's reputation for excellence has been earned through hundreds of good reviews and awards from the most respected reviewers in the industry, who listen to music every day. Their comments keep the company true to its goal - the pursuit of equipment that is musical, reliable and affordable.

All of us at Rotel, thank you for buying this product and hope it will bring you many years of enjoyment.

"DTS", "DTS-ES Extended Surround", "DTS ES® Matrix 6.1", and "DTS ES® Discrete 6.1" are trademarks of Digital Theater Systems, Inc.

Manufactured under license from Dolby Laboratories Licensing Corporation. "Dolby", "Pro Logic II", "Dolby Surround", "Dolby Digital", and the double-D symbol are trademarks of Dolby Laboratories Licensing Corporation. Confidential unpublished works © 1992 – 1997 Dolby Laboratories, Inc. All rights reserved.

HDCD®, HDCD®, High Definition Compatible Digital® and Pacific Microsonics™ are either registered trademarks or trademarks of Pacific Microsonics, Inc. in the United States and/or other countries. HDCD system manufactured under license from Pacific Microsonics, Inc. This product is covered by one or more of the following: In the USA: 5,479,168, 5,638,074, 5,640,161, 5,808,574, 5,838,274, 5,854,600, 5,864,311, 5,872,531, and in Australia: 669114. Other patents pending.

Getting Started

Thank you for purchasing the Rotel RSX-1065 Surround Sound Receiver. The RSX-1065 is four products in one:

1. A digital audio/video processor with Dolby® Pro Logic® decoding for Dolby Surround® source material. Dolby Digital® and DTS® processing for digital surround sound signals.
2. A full-featured audio/video control center for analog and digital source components.
3. A high-quality AM/FM tuner with RDS capability.
4. A 5-channel power amplifier to drive two front speakers, a center channel speaker, and two rear surround speakers.

Key Features

- Rotel's Balanced Design Concept combines advanced circuit board layout, comprehensive parts evaluation, and extensive listening tests for superior sound and long term reliability.
- Dolby® Pro Logic II® decoding for Dolby Surround® analog sources and conventional stereo movie and music sources.
- Automatic decoding for Dolby Digital® 5.1 channel digital sources.
- Automatic decoding for DTS® 5.1 channel, DTS ES® Matrix 6.1 channel, and DTS ES® Discrete 6.1 channel digital sources.
- Automatic HDCD® decoding for signals from High Definition Compatible Digital® compact discs.
- Surround modes for playback of surround sound material on 2 channel and 3 channel systems for total compatibility.
- Surround modes for playing any source material on 5 channel, 6 channel, or 7 channel systems.
- Digital and analog input and output connections for digital signals, composite video, S-Video, and Component Video.

- Five built-in amplifier channels, each delivering 100 watts (all channels driven).
- AM/FM tuner with 30 station presets, direct access tuning, and auto-tuning.
- RDS (Radio Data Systems) and RBDS (Radio Broadcast Data Service) capability.
- Zone 2 output with independent input selection and volume adjustments for multi-zone custom installations along with IR-repeater capability for operation from the remote zone.
- MULTI Input for outboard adaptor and future upgradeability
- User friendly ON-SCREEN DISPLAY with programmable labels for video components. Choice of English or German languages.
- Universal learning remote control to operate the RSX-1065 and nine other components.
- Upgradeable microprocessor software to accommodate future upgrades.

Unpacking

Remove the unit carefully from its packing. Find the remote control and other accessories. Save the box as it will protect the RSX-1065 if you move or need to return it for maintenance.

Placement

Place the RSX-1065 on a solid, level surface away from sunlight, heat, moisture, or vibration. Make sure that the shelf can support the weight of the unit.

Place the RSX-1065 close to the other components in your system and, if possible, on its own shelf. This will make initial hookup, and subsequent system changes easier.

The RSX-1065 can generate heat during normal operation. Do not block ventilation openings. Allow a minimum of 10 cm (4 inches) of unobstructed space around the unit. If installed in a cabinet, make sure that there is adequate ventilation.

Don't stack other components or objects on top of the RSX-1065. Don't let any liquid fall into the unit.

RR-969 Remote Control

The RSX-1065 includes a full-function learning remote control that can operate the RSX-1065 plus nine other components.

A separate manual, included with the remote, gives detailed instructions on programming and using the RR-969 to replace all of the remote controls in your system. To avoid duplication, we provide only basic information about using the RR-969 to operate the RSX-1065 in this manual.

Most of the RR-969 functions duplicate the front-panel controls. For that reason, we will cover the operating controls on the remote in the appropriate sections of this manual. Letters in gray boxes next to the name of a function refers to the labeled illustration of the remote at the front of this manual.

Using the RR-969 **A**

To operate the RSX-1065 with the remote, make sure that the AUDIO mode is active by pressing the AUD button **A** on the remote before you start. The AUDIO mode will stay active until another DEVICE button is pressed.

Programming the RR-969 **Y**

The RR-969 is preprogrammed to operate the RSX-1065. Should the AUDIO command set on your RR-969 not operate the RSX-1065, the programming may have been changed. To restore the RSX-1065 programming, press the recessed PRELOAD button **Y** on the remote with the tip of a ballpoint pen.

NOTE: Pushing the PRELOAD button will erase all custom programming and learned commands, restoring the RR-969 to its factory condition.

Basic Controls

We suggest you look over the RSX-1065's front and rear panels before you start connecting other components. The following explanations will help you get familiar with the unit's connections, features, and controls.

Most functions are duplicated on the front-panel and on the remote. A few are found only on one or the other. Throughout this manual, numbers in gray boxes refer to the RSX-1065 illustration at the front of this manual. Letters refer to the RR-969 remote illustration. When both appear, the function is found on both the RSX-1065 and the remote. When only one appears, that function is found only on the RSX-1065 or the remote.

POWER Switch **20 K**

The front-panel POWER switch on the RSX-1065 is a master power control. It must be pressed IN for the unit to operate. When it is in the OUT position, the unit is fully off and cannot be activated from the remote control. The POWER switch on the remote functions as a standby switch, activating or deactivating the unit. In standby mode, minimal power is still supplied to memory circuits to preserve settings. When the unit has AC power applied and the front-panel POWER button is pressed IN, the front-panel POWER LED lights, regardless of whether the unit is in standby mode or fully-activated in the main room.

There are three available power mode options for the RSX-1065, selected during setup from an ON-SCREEN DISPLAY menu. The default DIRECT mode fully activates the unit whenever AC power is supplied and the front-panel POWER button is pressed IN; however, the remote POWER switch can still be used to activate or deactivate the unit. With the STANDBY power option, the unit powers up in standby mode when AC is first applied and the front-panel POWER button is pressed IN. The unit must be manually activated with the remote control POWER button. With the ALWAYS-ON power option, the unit is fully operational whenever AC is applied and the front-panel POWER button is pressed IN. The remote POWER button is disabled.

When using Zone 2, the standby operation is completely independent for the main room and Zone 2. The remote control POWER button will not affect Zone 2. Pressing the POWER button on a remote located in Zone 2 will only affect that zone and not the main room. When the unit is activated in ZONE 2, the ZONE indicator in the front-panel FL DISPLAY is lit.

Remote Sensor **2**

This sensor receives IR signals from the remote control. Do not block this sensor.

Front-panel Display **3**

The fluorescent (FL) display in the upper portion of the RSX-1065 provides information about the status of the unit and activation of special features.

See the illustration at the front of this manual for the location of each section of the display:

Listening Source **3B** displays the current input source selected for listening.

Recording Source **3D** displays the current input source selected for recording.

Status Display **3C** shows a range of information depending on the current operating mode. For example, when the tuner is selected, this section of the display shows tuning information and/or RDS information. When other sources are selected, the surround sound mode will be displayed. Additionally, other information may be displayed briefly when a feature is activated.

Volume information **3E** shows the current volume setting and/or mute status.

Icons **3A** appear along the left side and the bottom of the display. These indicate when special features are activated and assist in the operation of the unit.

The FL display can be turned off, if desired. See the MENU button section for instructions.

Volume Control **4 M**

The VOLUME control adjusts the level of all output channels. Rotate the front-panel control clockwise to increase the volume, counterclockwise to decrease. The RR-969 remote has VOLUME UP and DOWN buttons.

When you adjust the volume, a digital read-out appears in the front-panel display and the new setting appears on your TV monitor.

NOTE: The *VOLUME* control can be used to change the volume in Zone 2. Press the front-panel *ZONE* button and adjust the volume. After 10 seconds, the *VOLUME* control reverts to normal operation.

MUTE Button

Push the MUTE button once to turn the sound off. An indication appears in the front-panel and on-screen displays. Press the button again to restore previous volume levels.

Tone Controls

BASS and TREBLE controls increase or decrease the audio signal's low and high frequency content respectively. Rotate clockwise to increase output and counterclockwise to reduce. The front-panel display and ON-SCREEN DISPLAY show tone control settings as you adjust them.

FILTER Button

The FILTER button (remote only) activates or deactivates a special CINEMA EQ setting. This equalization may be desirable for playback of movie source material to compensate for the acoustic differences between a commercial cinema and a home theater environment.

MENU Button

Push this button on the remote to turn on the ON-SCREEN DISPLAY menu system. If the menu system is already visible, push this button to cancel the display.

The front panel FL display can be turned off by pressing and holding the MENU button on the remote for three seconds. The display is turned back on when any button on the remote or the front-panel is pressed.

ENTER Button

The ENTER button is used to confirm and memorize various settings in the setup and operation of the RSX-1065. Its use is described in detail in the relevant sections.

Input Controls

Input Source Buttons

Press any of the eight front-panel buttons to select an audio or video input source (the built-in tuner, CD, VCR, etc.) for listening. You will hear this source and, if you have selected a video source, see its picture on your TV monitor.



The front-panel display and the ON-SCREEN DISPLAY will show the name of the current listening source selection. The labels for VIDEO sources can be customized to match your components.

All of the inputs (the five video inputs, the CD input, and the TAPE input) can accept either analog signals or digital signals from one of the five assignable digital inputs. When a digital input is assigned, the RSX-1065 checks for the presence of a digital signal at that input. If a digital signal is present when the source is selected, it is automatically activated and the proper surround mode enabled. If no digital signal is present, the analog inputs for that source are selected. This auto-sensing is the preferred configuration for digital source inputs such as DVD players. When an ANALOG input is assigned, the unit will not access a digital signal, even though one may be available at the digital input.

By default, the source input buttons are factory configured to select the following inputs:

CD:	Analog input
Tuner:	Analog input
Tape:	Analog input
Video 1:	Digital Coaxial 1
Video 2:	Digital Coaxial 2
Video 3:	Digital Coaxial 3
Video 4:	Digital Optical 1
Video 5:	Digital Optical 2

Each source input button can be configured using the ON-SCREEN DISPLAY menu system to use a different input (analog or digital). See the INPUT MENU section for configuration instructions.

The input source buttons can also be used (with the REC button  described in the next section) to select an analog input source signal to be available at the outputs for recording. Additionally, the input source buttons can be used with the ZONE button  to select an analog input source for ZONE 2.

REC Button ZONE Button

The RSX-1065 can record from any analog source to a VCR or other recorder connected to the VIDEO 1, 2 or 3 outputs or the TAPE outputs, even while you are listening to a different input source. To select an input source for recording, press the REC button on the front-panel (or the equivalent ZONE button on the remote). Then, press one of the INPUT SOURCE buttons within 5 seconds to select the signal you wish to record. After making your selection (or if more than five seconds passes), the input source buttons return to their normal function, selecting a listening source.

Remember, this selection is independent of the listening source. While recording, you may still select a different source (for example, the built-in tuner) for listening. The record selection appears in the display to the right of the listening selection.

NOTE: The *RECORD* function requires analog signals. If you use a digital connection from a CD player or DVD for listening, you should also connect an analog signal for recording.

MULTI Input EXT IN

The MULTI CH button (or the EXT IN button on the remote) overrides all other audio inputs (both analog and digital) and selects the audio signal from an external digital adaptor. This input only changes the audio signal; the video signal from the currently selected input remains in use. When activated, the RSX-1065's digital processing is bypassed. An indicator appears in the front-panel display.

NOTE: When the *MULTI CH* input is selected, the *CB* output is available only at the *CB1 PREOUT* connector. No signal is available at the *CB2 PREOUT* connector when the *MULTI CH* input is selected.

Surround Sound Controls

The RSX-1065 decodes Dolby Surround® analog sources, Dolby Digital® and DTS® 5.1 channel digital sources, DTS ES® Matrix 6.1 DTS ES® Discrete 6.1 channel digital sources, HDCD® encoded compact discs as well as providing several DSP ambience simulations for music and the ability to derive 5-channel, 6-channel, and 7-channel surround sound from any source material.

Decoding of digital input streams is generally automatic. For example, when a digital input signal encoded in Dolby Digital or DTS 5.1 channel surround is detected, the RSX-1065 activates the proper decoding. In addition, the unit will detect discs encoded with DTS-ES Matrix 6.1 or DTS-ES Discrete 6.1 surround information and activate DTS ES® Extended Surround decoding. Likewise, a digital input from an HDCD® encoded compact disc will be auto-detected and properly decoded to 2CH stereo operation.

In most cases, the RSX-1065 will also recognize a digital signal with Dolby Surround encoding and activate the proper Dolby® Pro Logic II® decoding. Additionally, you can configure a default surround mode for each input using the ON-SCREEN DISPLAY menu system.

Four front panel MODE buttons and the SUR+ button on the remote allow manual control of the surround sound settings, overriding any configured default setting or auto-sensing. Optional settings available from the front panel and/or the remote include:

- 2-channel stereo (left/right)
- 3-channel stereo (left/right/center)
- 5-channel stereo (front left/front right/center/surround left/surround right)
- 7-channel stereo (front left/front right/center/surround left/surround right/center back 1 and 2).
- Four DSP ambience settings simulating concert halls.

These options enable you to enjoy expanded surround sound performance from conventional stereo and 5.1 channel surround material or to play multichannel surround source material on systems with just 2 or 3 speakers.

The manual surround sound options are generally used with source material that is not encoded with a specific surround sound format. They are only available for certain source material and surround modes, but not for some surround material which triggers automatic decoding, as follows:

- DTS, DTS-ES Matrix 6.1, DTS-ES Discrete 6.1, Dolby Digital, HDCD (96kHz), and PCM 2-channel (96kHz) digital signals are auto-detected cannot not be overridden.
- HDCD (non 96kHz) and PCM 2-channel (non 96kHz) digital signals can be overridden to Dolby Pro Logic II, Dolby 3-Stereo, Music 1 – 4, 5CH Stereo, 7CH Stereo, and Stereo.
- Dolby Digital 2-ch Stereo digital can be overridden to Dolby Pro Logic II, Dolby 3-Stereo, and Stereo.
- All other mode settings can be overridden.

PRO LOGIC II Button 7

This setting decodes Dolby Surround encoded analog surround sound signals, whether it be a music CD, videotape, videodisc, stereo TV broadcast, or radio broadcast. It also can be used to create additional ambience in 2-channel musical source material. Front, center, and rear speakers are activated. An indicator lights in the front-panel display when the PRO LOGIC II button is pressed.

NOTE: Leaving the RSX-1065 in PRO LOGIC II mode offers satisfactory performance and convenience for many source materials. It provides automatic decoding of analog surround sound material and automatic selection of Dolby Digital or DTS processing when an appropriate digital source is played.

3 STEREO Button 6

This mode provides proper playback on 3-channel systems that have front and center speakers, but lack rear surround speakers. With stereo recordings, it derives a center channel signal. With 5.1 channel surround sound recordings, it mixes the rear channel signals into the front speakers for a larger, more ambient sound than conventional stereo. An indicator lights in the front-panel display to show that this mode has been activated.

DSP Button 8

This button activates digital synthesis of six ambience modes (MUSIC 1, MUSIC 2, MUSIC 3, MUSIC 4, 5CH Stereo, and 7CH Stereo).

- The four MUSIC settings simulate progressively larger acoustic environments and are used to recreate ambience when listening to music sources and/or other sources that lack surround sound encoding.
- The 5CH Stereo setting is used to derive surround information from stereo source material appropriate for use with a 5 channel system (FRONT LEFT/RIGHT, CENTER, and SURROUND LEFT/RIGHT).
- The 7CH Stereo mode derives surround information from any source material for a seven speaker system (FRONT LEFT/RIGHT, CENTER, SURROUND LEFT/RIGHT, and CENTER BACK 1/2).

Press the button to activate the DSP mode. Each press of the button will step forward to the next mode in the following order: MUSIC 1 > MUSIC 2 > MUSIC 3 > MUSIC 4 > 5CH Stereo > 7CH Stereo. An indicator lights in the front-panel display when DSP mode has been activated.

NOTE: As a general rule, the DSP modes provide more exaggerated ambience effects than the PRO LOGIC II mode. Experiment with the more spectacular DSP modes for particular recordings or effects.

2CH Button 5

This button activates conventional 2-speaker stereo mode with no surround sound or other processing. This is "pure" stereo, using the front left and front right speakers (with or without subwoofer), with no surround channels and no center channel.

When used with Dolby Digital or DTS source material, the 2CH button engages a downmix feature, combining all of the channels and sending them to the front speakers. The spatial effects of surround sound are lost, but all of the information on the original recording are preserved.

NOTE: 2CH mode allows you to hear 2-channel stereo recordings in their original format using the analog inputs.

SUR+ Button **V**

The SUR+ button on the remote selects the surround modes described in the previous section. Each time you press the button, the surround mode cycles to the next setting (Dolby Pro Logic II, Dolby 3-Stereo, Music 1 – 4, 5CH Stereo, 7CH Stereo, and Stereo) as indicated by the front-panel display and an ON-SCREEN DISPLAY indicator. Repeatedly press the button until you reach the desired setting.

NOTE: These surround modes may not be available for all source material. Many types of digital sources automatically trigger a specific type of surround decoding, which cannot be overridden.

Speaker Level Adjustment Selection Buttons **C E S** UP/DOWN Buttons **D**

The levels of all channels should be calibrated using test tones with an ON-SCREEN DISPLAY menu during the initial setup of the RSX-1065. You can also make a temporary change in the relative volume of the center, rear, or subwoofer channels using buttons on the remote control:

1. Press one of the selection buttons on the remote to select a channel (or pair of channels) for adjustment. Press the C button **C** to adjust the CENTER channel. Press the S button **S** to adjust the SUBWOOFER channel. Press the R button **S** to adjust the rear SURROUND or CENTER BACK channels (each press of the R button toggles between the SURROUND channels and the CENTER BACK channels). The selected speaker and its current setting appear briefly in the display.
2. Use the UP or DOWN buttons **D** on the remote to adjust the output level of the selected channel(s).
3. Repeat the procedure for each channel.

If no level adjustment is made for 5 seconds after pressing one of the selection buttons, the levels revert to the default calibrated settings.

NOTE: This adjustment is temporary. Selecting a different input or turning the unit off and one will cause the settings to revert to the default levels.

NOTE: The ON-SCREEN DISPLAY calibration permits independent adjustment of each surround channel. The adjustment procedure described here only allows changing the relative volume of all surround channels in unison.

DYNAMIC RANGE Button **10** DWN Button **D**

Digital sources are capable of wide dynamic range (the difference between the softest and loudest sounds). In some cases, this may tax amplifiers and/or speakers. In other cases, you may want to reduce the dynamic range when listening at low volume levels. Pressing the front-panel DYNAMIC RANGE button (or the DWN button on the remote) steps through the three dynamic range settings:

- **MAX** (no compression/full dynamic range)
- **MID** (moderate compression)
- **MIN** (full compression/minimum dynamic range)

A "D. RANGE" indicator in the front-panel display lights when the dynamic range is not set to the MAX setting. The new dynamic range setting appears briefly in the alphanumeric display when the setting is changed.

NOTE: The DYNAMIC RANGE feature is only available in Dolby Digital mode. It is inactive at all other times.

Tuner Controls

The RSX-1065 features a digital synthesized AM/FM tuner with RDS capability and 30 station presets. The unit offers a wide range of tuning options. Here is an overview of the tuning options (more detailed information is provided in subsequent sections of this manual):

- **Manual frequency tuning** tunes up or down to the next station frequency (when in frequency tuning mode). Press and release a TUNING button (CH UP/DOWN on the remote) to tune.
- **Direct frequency tuning** lets you enter the desired station frequency digits. Press the DIRECT button and enter the digits using the NUMERIC buttons.
- **Automatic frequency search tuning** searches up or down to find the next receivable broadcast signal. Press and hold a TUNING button (CH UP/DOWN on the remote) for at least one second to search up or down.
- **Station preset tuning** lets you directly enter the number of a memorized station preset. Enter the number of the memorized preset using the NUMERIC buttons.
- **Preset search tuning** jumps up/down to the next memorized station preset. When in PRESET mode, press a TUNING button (CH UP/DOWN on the remote) to select the next station preset. Press the PRESET button on the remote to toggle between preset and frequency tuning modes.
- **RDS (Europe) or RBDS (USA) tuning** provides a range of special tuning and search features based on data codes encoded with the broadcast signal. See the RDS section of this manual for detailed information.

NOTE: The RSX-1065 comes preconfigured for tuning in the market where you purchased it (N. America or Europe). To change this default setting, see the information on the DEFAULT SETUP on-screen menu later in this manual.

BAND Button **13** **N**

Press the BAND button to toggle between AM and FM reception. An indicator in the front-panel display confirms your choice and the currently tuned station frequency is shown.

NOTE: If the TUNER is not already the selected input source, pressing the BAND button will automatically switch to the TUNER input.

TUNING Buttons **15** **L**

The TUNING buttons (labeled CH UP/DOWN on the remote control) provide three different tuning functions, depending on the mode of operation.

In the normal FREQUENCY tuning mode, press a TUNING button (CH UP/DOWN on the remote) and release to manually jump to the next station frequency, regardless of whether or not a station is broadcasting on that frequency. For auto frequency search tuning, press and hold the TUNING button for approximately one second. An AUTO indicator will appear in the front-panel display and the tuner will begin scanning up or down through the frequencies until the next available signal is detected. If this is not the desired station, repeat the automatic tuning procedure to find the next station. Weak stations will be skipped during auto tuning.

In the PRESET tuning mode, press a TUNING button (CH UP/DOWN on the remote) and release to jump to the next memorized station preset. Switch between FREQUENCY and PRESET tuning modes by pressing the PRESET button **U** on the remote control. A PRESET indicator appears in the display when PRESET TUNING is activated.

In the RDS PTY search mode, press a TUNING button (CH UP/DOWN on the remote) to select the desired program type from the scrolling list in the display. See the section on RDS tuning for more details.

NOTE: Several indicators in the front-panel display assist tuning. A large display shows the tuned frequency. A TUNED indicator lights when a sufficiently strong signal is received. A ST indicator lights when a stereo FM signal is received.

NOTE: If the TUNER is not already the selected input source, pressing a TUNING button (CH UP/DOWN on the remote) will automatically switch to the TUNER input.

MEMORY Button **17**

The MEMORY button is used with the NUMERIC buttons to store memorized station presets. See the next section for detailed instructions.

NUMERIC Buttons: Station Presets **13** **B**

The RSX-1065 can store up to 30 station presets for recall at any time using the NUMERIC buttons. To memorize a station:

1. Tune to the desired station, AM or FM.
2. Press the MEMORY button on the front-panel. A MEMORY indicator will flash for five seconds in the front-panel display.
3. While the MEMORY indicator is flashing, press the number of the preset where you wish to store the station frequency. For example, to memorize the station as preset 3, press the 3 button. To memorize preset 15, press the 1 button followed by the 5 button.
4. A previously stored frequency is erased from memory when a new frequency is memorized for the same preset number.

To tune to a previously memorized station, just press the preset number on the NUMERIC buttons. For example, to tune to preset 3, press the 3 button. To tune to preset 15, press the 1 button and then press the 5 button.

NOTE: If the TUNER is not already the selected input source, pressing a NUMERIC button will automatically switch to the TUNER input.

The NUMERIC buttons can also be used for direct access tuning (see next section).

DIRECT Button **14**

If you know the frequency of the desired station, you may tune it directly using the DIRECT button and the NUMERIC buttons.

1. Press the DIRECT button to change the NUMERIC buttons from station preset to Direct Access mode. The station frequency in the front-panel display will change to a series of four bars, representing the digits of a station frequency, with the first bar flashing.

2. Enter the first digit of the station frequency using the NUMERIC buttons. The digit will appear in the frequency display and the second bar will flash. Enter the remaining digits of the frequency. Note that in FM mode, pressing 1 will enter 10 as the digit in the frequency display. When all of the necessary digits have been entered (a final 0 is displayed automatically), the receiver will tune to the displayed station frequency.

Examples:

FM87.50MHz Press: 8 > 7 > 5

FM101.90MHz Press: 1 > 1 > 9

AM1610kHz Press: 1 > 6 > 1

MONO Button **16**

The MONO button changes the FM mode from stereo reception to mono reception. In stereo mode, a stereo signal will be heard if the station is broadcasting a stereo signal and there is sufficient signal strength. An ST indicator will light in the front-panel display. In mono mode, a mono signal will be heard even if the station is broadcasting a stereo signal.

NOTE: Switching to mono mode can improve the reception of weak or distant FM signals. Less signal strength is required for clean mono reception than for stereo reception.

PRESET Button **U**

The PRESET button on the remote toggles between frequency tuning mode and preset tuning mode. In frequency tuning mode, the TUNING buttons (CH UP/DOWN on the remote) advance to the next station frequency. In preset tuning mode, the TUNING buttons advance to the next memorized station preset. A PRESET indicator in the front-panel display lights in preset mode.

RDS and RBDS Broadcast Reception

The Rotel RSX-1065 is equipped with RDS (Radio Data Systems) reception capabilities for Europe and RBDS (Radio Broadcast Data Service) capabilities for the United States. These broadcast systems provide additional functionality to FM radio reception by transmitting encoded information along with the radio signal. This signal is decoded by an RDS or RBDS receiver and can provide a range of informational features including:

1. a display of the station's identifying name (e.g. BBC1)
2. a display of the station's program content (e.g. ROCK or NEWS)
3. traffic information broadcasts
4. a scrolling text display for announcements or information

In addition, RDS provides several advanced search features including:

1. Search for a station with the desired program content (PTY)
2. Search for traffic information (TP)
3. Search for stations broadcasting special traffic announcements (TA).

RDS broadcasting has been widely available in many European markets for years. There are a large number of RDS stations and most users will be familiar with the features and operation. In the USA, implementation of the RBDS system is more recent. Fewer stations are broadcasting RBDS signals and the features may be less familiar to many users. Consult your authorized Rotel dealer for more information on RDS or RBDS broadcasting in your area.

NOTE: The RDS and RBDS features are entirely dependent on the broadcaster sending encoded signals. Thus, they will only be available in markets where RDS or RBDS is implemented and where stations are broadcasting these data signals. If there are no RDS or RBDS stations, the RSX-1065 will function as a standard radio receiver.

NOTE: RDS and RBDS services are only available on FM broadcasts. The features and buttons described below are only operational in FM mode.

DISPLAY Button **W**

There are five display options when the currently tuned station is broadcasting RDS information and the RDS indicator in the front-panel display is lit. Press the DISPLAY button on the remote to step through the five display options:

1. Standard FREQUENCY display.
2. PROGRAM SERVICE name. This is typically the station's call letters, such as BBC1. If the current station is not broadcasting an RDS signal, the display will show "NO NAME DATA".
3. PROGRAM TYPE. This is a description of the station's content from a standardized list of program types in each market. If the current station is not broadcasting an RDS signal, the display will show "NO PTY DATA".
4. CLOCK TIME. A time and date display broadcast by the station. If the current station is not broadcasting an RDS signal, the display will show "NO TIME DATA".
5. RADIO TEXT. Additional scrolling text messages broadcast by the station. If the current station is broadcasting radio text data, an RT indicator lights in the display and the scrolling text appears. If the current station is not broadcasting an RDS signal, the display will show "NO TEXT DATA".

PTY Button **I**

The PTY search function permits you to scan available broadcasts for RDS stations broadcasting a particular type of program content.

1. Press the PTY button. The current RDS program type will appear in the display.
2. If desired, change to a different PROGRAM TYPE using the TUNING UP/DOWN buttons to scroll through the list.
3. Press the PTY button a second time within 5 seconds. The tuner will attempt to find an RDS station broadcasting the selected type of program. If the button is not pressed within 5 seconds after selecting a program type, the PTY function will be cancelled.
4. If no station is located for the desired content type, the tuner will return to the last previously tuned station.
5. Cancel the PTY function by pressing any other button.

NOTE: If the currently tuned station is broadcasting PTY data, a PTY indicator lights in the front-panel display.

TP Button **X**

Searches for an RDS station broadcasting traffic information programming:

1. Press the TP button. The tuner attempts to find an RDS station broadcasting the traffic programming. If a station is found, a TP indicator lights in the front-panel display.
2. If no station is located, the tuner will return to the last previously tuned station.
3. Cancel the TP function by pressing any other button.

TA Button **J**

Searches for an RDS station broadcasting special traffic announcements:

1. Press the TA button. The tuner will attempt to find an RDS station broadcasting traffic announcements.
2. If no station is located, the tuner will return to the last previously tuned station.
3. Cancel the TA function by pressing any other button.

Connections: Overview

The RSX-1065 connections include standard RCA audio inputs and outputs, composite video inputs and outputs, S-Video inputs and outputs, Component Video inputs, plus coaxial and optical digital inputs and outputs.

The RSX-1065 has RCA preamp audio outputs for use with external amplifiers as well as composite video, S-Video, and Component Video outputs to connect your TV monitor.

The RSX-1065 also has MULTI input connections, a remote IR sensor input, and two 12V trigger connections for remote turn-on of Rotel amplifiers.

NOTE: Do **not** plug any system component into an AC source until all connections have been properly made.

Video cables should have a 75 ohm impedance rating. The S/PDIF digital audio interface standard also specifies a 75 ohm impedance and all good digital cables adhere to this requirement. Because the video and S/PDIF standards are so close, you can use a video cable for digital audio data transmission. We strongly advise that you NOT substitute conventional audio interconnect cables for digital or video signals. Standard audio interconnects will pass these signals, but their limited bandwidth reduce performance.

When making signal connections, connect LEFT channels to LEFT channel jacks and RIGHT channels to RIGHT channel jacks. All RCA-type connections on the RSX-1065 follow these standard color codes:

Left channel audio: white RCA jack

Right channel audio: red RCA jack

Composite video: yellow RCA jack

NOTE: Each source input must be properly configured using the INPUT MENU of the ON-SCREEN DISPLAY system. We recommend going to this menu after connecting each source to configure it as desired. See the INPUT MENU section for information.

Video Connections

The RSX-1065 provides S-Video and Component Video connections for those who wish to use them. However, standard Composite video cables provide excellent picture quality in most systems and their use for **all** input and output connections will greatly simplify installation and configuration of the unit.

If you chose to use S-Video or Component Video connections, be aware of the following implications for the configuration of your system:

On Screen Menu Display: The RSX-1065 ON-SCREEN MENU system is available for **all** inputs when using a Composite or S-Video cable from the TV MONITOR outputs to the TV set. The ON-SCREEN MENU is not available when using Component video cables.

System Set-Up: System setup should be done while using a Composite video or S-Video cable connecting the RSX-1065 TV MONITOR outputs to the video inputs of the TV or projector. Select OSD (ON-SCREEN MENU) from the RR-969 remote control to complete system setup.

NOTE: On a PAL standard monitor, the OSD cannot be displayed until a video signal is present, irrespective of the type of video cables in use. For setup, connect the video output from your DVD player and select its input on the RSX-1065. The OSD will be displayed as an overlay to the video signal from the DVD player.

Composite and S-Video: With certain exceptions, a system should be connected with either **all** Composite or **all** S-Video cables. S-Video signals from sources cannot be sent to a TV set from the RSX-1065 TV MONITOR outputs with a Composite video cable. Conversely, Composite video signals from sources cannot be sent to a TV set from the RSX-1065 TV MONITOR outputs with an S-Video cable. Therefore, Composite and S-Video connections cannot be "mixed" in a system.

However, both Composite and S-Video cables may be connected from the RSX-1065 TV MONITOR outputs to both Composite and S-Video inputs on a TV or projector. This dual connection from the RSX-1065 will provide limited S-Video capability in a system that is predominantly connected with Composite video cables.

When both Composite and S-Video cables are connected from the same source, **only** S-Video will be available at the RSX-1065 S-Video TV MONITOR outputs. However, the Composite video REC Out will still be available. This dual connection can be used to provide video taping in a system that is predominantly connected with S-Video cables, but also includes a VCR with Composite video.

Audio Source Connections

Connect your audio-only source components to these RCA inputs and outputs:

CD Inputs

Connect the left and right analog outputs from your CD player to the input jacks labeled CD.

TAPE Inputs and Outputs

The RSX-1065 provides a pair of inputs and a pair of record outputs for connecting an analog audio tape deck.

The analog source signal available for recording at the TAPE outputs is selected with the REC button on the front-panel (or the ZONE button on the remote) and its label appears in the display. If the TAPE input signal is selected as the recording source, its signal will not be available at the TAPE output, but will be available at the VIDEO outputs for recording.

Connect the left and right analog *outputs* from an audio tape deck to the TAPE IN jacks. Connect the TAPE OUT jacks to the *inputs* on the audio tape deck.

Video Source Inputs

There are input connections for five video source components. Each of the five provides a pair of RCA inputs for analog audio signals. Each of the five also provides a choice of an RCA composite video input or S-Video input for the video signal from the source component. In addition, two of the video source inputs (Video 1 and Video 2) also feature Component Video input connections as an alternative to the composite video or S-Video connections.

NOTE: *There is no need to use more than one type of video connection from a source component. We recommend selecting one type of video connection and using it for all video inputs and outputs. As a general rule, using RCA composite video connections will simplify system setup and operation.*

There are also video record outputs (described in a following section) which correspond to three of the video source inputs – Video 1, 2, and 3). For this reason, you should plan ahead and designate each source component as Video 1, Video 2, etc. All connections (both input and output) from a source component must be made consistently to the same set of connections. For example, **all** input and output connections to a particular VCR could be made to Video 1 connectors.

Also, be sure that the channels are connected consistently, i.e. left channel signals connected to left channel inputs/outputs and right channel signals connected to right channel inputs/outputs.

NOTE: *These video source inputs can also be used for additional audio-only sources, omitting the video signal connections.*

VIDEO 1–5 Audio Inputs 43

Using standard audio interconnect cables, connect the left and right channel analog *outputs* of VCRs or other source components to the VIDEO 1, 2, 3, 4, or 5 *inputs* using standard RCA audio cables.

VIDEO 1–5 Composite Video Inputs 36

If you use the RCA composite video connections for a source component, connect the RCA video *output* of the source component to one of the video *inputs* labeled COMPOSITE IN. Use a standard 75 ohm video cable.

VIDEO 1–5 S-Video Inputs 40

S-Video signals use a special cable which divides the video signal into several elements carried by separate conductors, providing higher quality than the standard RCA composite cables. If you choose to use an S-Video input connection from a source component, connect the S-Video *output* of that component to one of the *inputs* on the RSX-1065 labeled S-VIDEO IN using a standard S-Video interconnect cable.

NOTE: *Signals from S-Video inputs will only be available at the S-Video outputs to the TV.*

VIDEO 1–2 Component Video Inputs 23

Component Video connections split the video into three signals – luminance (Y) and separate chrominance (CB and CR) elements, allowing delivery of a reference-quality picture. Each of these signals is carried by a separate 75 ohm video cable with RCA connectors.

The VIDEO 1 and VIDEO 2 source inputs provide an option for using Component Video connections. If you choose to use Component Video input connection from a source component, connect the three Component Video *outputs* of that component to the corresponding *inputs* on the RSX-1065 labeled COMPONENT VIDEO IN. Make sure that you connect each of the three cables to the proper connector (Y to Y, CB to CB, and CR to CR) and that you use standard 75 ohm video interconnect cables.

NOTE: *Signals from Component Video inputs will only be available at the Component Video outputs to the TV monitor. The ON-SCREEN DISPLAY system is not available when using Component Video connections.*

MULTI Channel Audio Inputs 32

A set of RCA inputs accepts seven channels of analog signals from a 5.1 or 6.1 channel processor or source component. When selected with the front-panel MULTI INPUT button or remote EXT IN button, this input overrides any other audio input signal.

Use audio interconnect cables to connect the outputs of the source component to the RCA jacks labeled MULTI INPUT, making sure that you observe proper channel consistency, i.e. connect the right front channel to the R FRONT input, etc. Depending on your system configuration, you will make six connections (FRONT RIGHT/FRONT LEFT/REAR RIGHT/REAR LEFT/CENTER/SUBWOOFER), seven connections (FRONT RIGHT/FRONT LEFT/ REAR RIGHT/ REAR LEFT/CENTER/CENTER BACK/SUBWOOFER).

Video Source Outputs

Three of the available video sources (VIDEO 1, 2 and 3) feature outputs that allow you to send a signal to a VCR or other source component for recording. The recording signal available at all of these outputs is selected globally using the REC button on the front-panel or the ZONE button on the remote and is independent of the source selected for listening.

NOTE: *Recording signals are available at all source outputs, including the source selected for recording. As a general rule, you should not attempt to record to the component whose signal has been selected for recording.*

The record outputs for VIDEO 1, 2, and 3 include a pair of RCA analog audio outputs plus a choice of composite video or S-Video output. To hook up a video component for recording, you will need to connect it to both analog audio outputs and to your choice of video outputs. Keep in mind that composite video input signals will not be available at the S-Video record outputs and S-Video input signals will not be available at the composite video record outputs.

NOTE: *All connections (both input and output) from a source component must be made consistently to the same set of connections. For example, if you designate a VCR as VIDEO 1, you must connect all of its input and output signals to the VIDEO 1 connectors.*

VIDEO 1-3 Audio Outputs 44

Using standard audio interconnect cables, connect the left and right channel RCA audio outputs from the RSX-1065 to the audio inputs on the source component. Make sure that you are consistent. If you hook up a VCR to the VIDEO 1 inputs, hook up the VIDEO 1 outputs to the same VCR. Also make sure that the left channel is connected to the LEFT connectors and the right channel to the RIGHT connectors.

VIDEO 1-3 Composite Video Outputs 37

If you choose to use the RCA composite video connections for a source component, use a 75 ohm video interconnect cable to connect the RSX-1065's RCA video output (labeled COMPOSITE OUT) to the RCA video input on your VCR.

VIDEO 1-3 S-Video Outputs 41

If you choose to use S-Video connections for a source component, use an S-Video cable to connect the RSX-1065's S-Video output (labeled S-VIDEO OUT) to the S-Video input on your source component.

Digital Source Connections

The RSX-1065 provides digital connections which may be used in place of, or in addition to, the analog audio input and output connections described in the previous sections. These connections include five digital inputs and a digital output for recording.

These digital connections can be used with any source component that supplies a digital signal, such as a DVD player or CD player.

NOTE: A digital connection means that the D/A converters in the RSX-1065 will be used to decode the digital signal, rather than the source component's internal D/A converters. In general, you would use digital connections for a DVD player or other component that supplies a Dolby Digital or DTS signal. However, if you are connecting a high-end Rotel CD player with sophisticated internal D/A converters, you might prefer to use analog audio connections to the RSX-1065.

Digital Inputs 24

The RSX-1065 accepts digital input signals from source components such as CD players, satellite TV receivers, and 5.1 channel Dolby Digital, DTS, or 6.1 channel DTS ES signals from DVD players. The built-in D/A converter senses and adjusts to the correct sampling rates.

There are five digital inputs on the rear panel, three coaxial and two optical. These digital inputs can be assigned to any of the input sources using the INPUT MENU screen described later in this manual. For example, you can assign the COAXIAL 1 digital input connector to the VIDEO 1 source and the OPTICAL 2 digital input to the VIDEO 3 source.

Connect the appropriate cable (optical or 75 ohm coaxial) from the digital output of your source component to a digital input on the RSX-1065 and then configure that digital input for use with the source component using the INPUT MENU.

NOTE: When using digital connections, you should also make the analog audio input connections described previously. The analog connection is necessary to record to an analog recorder or for ZONE 2 operation

Digital Outputs 25

The RSX-1065 has a digital output (with a choice of coaxial or optical connectors) to send the digital signal from any of the five digital inputs to a digital recorder or outboard digital processor. When a digital input source signal is selected for listening, that signal is automatically sent to both digital outputs for recording or outboard processing.

NOTE: Only digital signals from source components are available at these outputs. Analog signals cannot be converted and are not available at the digital outputs.

Connect the digital output to the digital input of your recorder or processor. You can use either a 75 ohm coaxial video cable or an optical cable.

Output Signal Connections

This section of the manual describes the audio and video signal output connections on the RSX-1065. These are used for routing the output signals to television monitors, audio amplifiers, and recording devices.

TV Monitor Output 23 38 42

The video output of the RSX-1065 sends the video signal to your TV monitor. Three types of video output connections are provided – RCA composite video, S-Video, and Component Video. Choose the type of video output connection that matches the type of video input connections you have made. Connect the TV MONITOR output, from either RCA composite or S-Video or Component Video connector, to the corresponding input on your television monitor, using appropriate video cables.

NOTE: The RCA composite video output only sends signals from RCA composite video source inputs to the TV monitor. The S-Video output only sends signals from S-Video video source inputs to the TV. The Component Video output only sends signals from Component Video source inputs to the TV. The ON-SCREEN DISPLAY system is not available when using Component Video connections.

Speaker Outputs 39

The RSX-1065 has five built-in amplifiers, two for the front (right and left), one for the center channel, and two for the rear surround speakers (right and left). There are five pairs of binding post connections (one pair for each speaker) which accept bare wire, spade lugs, or banana plug connectors (in some markets).

Each pair of connectors is color-coded for polarity: red/blue/green for positive and black for negative. All speakers and all speaker wire is also marked for polarity. For proper performance, you must maintain this polarity at all speaker connections. Always connect the positive terminal of each speaker to the corresponding colored (red/blue/green) speaker terminal on the RSX-1065 and the negative speaker terminal to the corresponding black connector on the RSX-1065.

Each pair of connectors is labeled as LEFT FRONT, LEFT SURROUND, RIGHT FRONT, RIGHT SURROUND, or CENTER. You must connect each of the five speakers to the proper terminal on the RSX-1065.

Route the wires from the RSX-1065 to the speakers. Leave enough slack so you can move the components to allow access to the speaker connectors. If you are using banana plugs, connect them to the wires and then plug into the backs of the binding posts. The collars of the binding posts should be screwed in all the way (clockwise). If you are using terminal lugs, connect them to the wires. If you are attaching bare wires directly to the binding posts, separate the wire conductors and strip back the insulation from the end of each conductor. Be careful not to cut into the wire strands. Unscrew the binding post collars. Place the connector lug or the twisted bare wire around the binding post shaft. Turn the collars clockwise to clamp the connector lug or wire firmly in place.

NOTE: Be sure that no loose wire strands can touch adjacent wires or connectors.

RCA Preamp Outputs 26

There are ten RCA preamp audio outputs: FRONT (LEFT/ RIGHT), CENTER (1/2), SURROUND REAR (LEFT/RIGHT), CENTER BACK (CB1/CB2), and SUBWOOFER (1/2). Use these outputs to send the RSX-1065's output signals to powered speakers or external amplifiers used in place of one or more of the internal amplifiers.

NOTE: Depending on your system configuration, you may use some or all of these connections. For example, if you only have one center channel, you would connect it to the CENTER 1 output. If you only have one center back channel, you would connect it to the CB1 output.

To hook up a powered subwoofer, connect a standard RCA audio cable from the SUBWOOFER OUTPUT jack to the input on the subwoofer's power amp.

To hook up the RCA main audio outputs, connect an audio cable from each output to the input of the amplifier channel that will power the corresponding speaker. In a full home theater system, you will need to make six different connections corresponding to the six speakers (left front, center front, right front, left surround, right surround, and subwoofer).

Make sure that you have each output connected to the correct amplifier channel (front right, left rear, etc.).

Antenna Connections

The RSX-1065 requires two antennas to receive radio signals, one for AM and one for FM. Most users will get acceptable reception using the indoor antennas which are supplied with the RSX-1065. Instructions for hooking up these antennas follow.

NOTE: If you are some distance from the radio transmitters, you may use an outdoor antenna to improve reception. Outdoor antenna systems can be dangerous if they are not properly grounded and should be installed by a professional contractor familiar with the electrical code requirements in your local area.

AM Loop Antenna 22

The RSX-1065 includes a plastic loop antenna to receive AM radio signals. Remove this antenna from the box and locate it near the RSX-1065. It can be tacked to a wall, using the mounting tab provided. Alternatively, you can fold the center portion of the antenna to form a tabletop stand.

Connect the 300 ohm twin-conductor wire from the loop antenna to the pair of screw terminals labeled AM LOOP, attaching one wire to each terminal. It does not matter which wire attaches to which terminal, but make sure that the connections are solid and that the two wires do not touch.

You may need to rotate or otherwise reorient the antenna to find the best position.

NOTE: To use an outdoor antenna, connect its 300 ohm twin-conductor wire to the terminals in place of the loop antenna.

FM Wire Antenna 21

The RSX-1065 is supplied with a T-shaped indoor FM antenna. Connect the attached coax F-type plug to one of the FM antenna connectors on the RSX-1065. For best reception, unfold the T-shaped antenna. Eyelets at both ends of the T allow tacking the antenna to a wall, if desired. Experiment with positioning for best reception.

NOTE: To use an outdoor antenna, connect its 75 ohm coax lead wire to the FM connector instead of the indoor wire antenna, only after a professional contractor has installed the antenna system in accordance with local electrical codes.

Power and Miscellaneous Connections

AC Input 46

Your RSX-1065 is configured at the factory for the proper AC line voltage in the country where you purchased it (USA: 115 volts/60Hz AC or CE: 230 volts /50 Hz AC). The AC line configuration is noted on a decal on the back of your unit.

Plug the supplied cord into the AC INPUT receptacle on the back of the unit.

See the POWER SWITCH heading in the BASIC CONTROLS section of this manual for information about turning the unit on and off.

NOTE: Memorized settings and video labels will be stored for up to one month if the RSX-1065 is disconnected from AC power.

Accessory Power Outlets 35 (North American version)

The RSX-1065 has two switched outlets on the back panel. Power is available from these outlets when the RSX-1065 is turned on. These outlets can provide up to a total of 200 watts. They are appropriate for supplying power to signal sources, such as CD players, tuners, or tape decks. They should not be used for power amplifiers. Connecting components that will draw more than 200 watts to these outputs could damage the RSX-1065.

12V TRIGGER Connections 31

Several Rotel amplifiers offer the option of turning them on and off using a 12 volt trigger signal. These two connections provide this 12 volt trigger signal. When the RSX-1065 is activated, a 12 volt DC signal appears at these connectors and will turn on amplifiers. When the RSX-1065 is put in STANDBY mode, the trigger signal is interrupted and the amplifiers will turn off.

EXTERNAL REM IN

This 3.5 mm mini-jack (labeled EXT REM IN) receives command codes from an industry-standard infrared receivers (Xantech, etc.) located in the main listening room. This feature is useful when the unit is installed in a cabinet and the front-panel sensor is blocked. Consult your authorized Rotel dealer for information on external receivers and the proper wiring of a jack to fit the mini-jack receptacle.

NOTE: The IR signals from the EXTERNAL REMOTE IN jack (as well as those from the ZONE REMOTE IN jack) can be relayed to source components using external IR emitters or hard-wired connections from the IR OUT jacks. See the ZONE 2 section of this manual for additional information.

Computer I/O Keypad

The RSX-1065 can be operated with a personal computer running audio system control software from third-party developers or with a dedicated A/V control keypad from Rotel. This control is accomplished by sending operating codes (normally sent by the RR-969 remote control) from the computer or keypad via a hard-wired network connection.

The COMPUTER I/O and KEYPAD inputs provides the necessary network connections on the back panel. They accept standard RJ-45 8-pin modular plugs, such as those commonly used in 10-BaseT UTP Ethernet cabling.

The COMPUTER I/O connector should be used when controlling the RSX-1065 for the main listening room. The KEYPAD connector should be used to connect a keypad for controlling the operations in ZONE 2. When using a KEYPAD in ZONE 2, the function is identical to that of an infrared repeater system connected to the ZONE REMOTE IN jack. See the following section for detailed information.

For additional information on the connections, software, and operating codes for computer or keypad control of the RSX-1065, contact your authorized Rotel dealer.

Zone 2 Connection and Operation

The RSX-1065 provides Zone 2 multi-room capability, allowing you to enjoy music and operate the system from a second room. From the remote location, you can select a source component (even if different from the source playing in the main listening room), adjust the volume level in the remote zone, and operate the source components.

To use the Zone 2 capability, you need additional components: a pair of speakers installed in the remote zone, an amplifier to drive them, and a third-party IR repeater or keypad system.

Zone 2 can be controlled from the main room using RSX-1065's front-panel ZONE button. Operation from the remote zone requires the installation of remote keypad compatible with the back panel RJ-45 8-pin modular KEYPAD connector or an infrared repeater system (Xantech, Niles, etc.) which relays infrared remote control commands from Zone 2 to the ZONE REMOTE IN input on the back of the RSX-1065.

Several points to keep in mind about the Zone 2 function:

- An infrared repeater system (Xantech, Niles, et al) or remote keypad is required for operation from the remote zone.
- There are two options for the Zone 2 output level, selectable from the ON-SCREEN DISPLAY menu system. VARIABLE output gives you full adjustment of the volume level, remembering last previous setting whenever Zone 2 is activated. FIXED output disables the Zone 2 volume control with the output permanently set to a specified level. This might be useful for sending a line level signal to a preamp or integrated amp with its own volume control or to a distribution amplifier with multiple autoformer-type volume controls.
- The RR-969 remote control supplied with the RSX-1065 will operate Zone 2 if used with a repeater system from the remote zone. It can also be programmed to operate Rotel source components via the RSX-1065's IR OUT jack.

- Any source component connected to the RSX-1065's analog inputs (except the MULTI input) can be sent to the Zone 2 outputs. ZONE 2 operates independently of the main room. You can select a different source or adjust Zone 2 volume without affecting the MAIN outputs in any way.
- Avoid sending the same infrared command to the RSX-1065 front-panel sensor and a Zone 2 repeater at the **same** time. This means that Zone 2 **must** be in a different room from the RSX-1065.

Zone 2 Power On/Off Operation

Once master power is applied to the unit by pressing the front-panel POWER button, the RSX-1065 provides independent power on/off operation for both zones. Pressing the remote control POWER button in the main room activates or deactivates the RSX-1065 in the main room only and has no effect on Zone 2. Conversely, activating or deactivating Zone 2 has no effect on the main listening room. However, placing the front-panel POWER button in the OFF position completely shuts off the unit, for both zones.

NOTE: For proper power on and off operation with Zone 2, the RSX-1065's power mode should be set to the factory default DIRECT setting or to the STANDBY setting using the OTHER OPTIONS menu from the ON-SCREEN DISPLAY.

Controlling Zone 2 from the Main Room ZONE Button

You can control Zone 2 from the front-panel of the RSX-1065 – activate or deactivate Zone 2, change input sources, and adjust the volume. Controlling Zone 2 from the front-panel is accomplished by pressing the ZONE button, which temporarily puts the RSX-1065 in Zone 2 control mode, even if the unit is in standby mode. When the ZONE button is pressed, the FL DISPLAY shows the current status of ZONE 2 for five seconds, during which time you can use the VOLUME control and INPUT SOURCE buttons to change the ZONE 2 settings. When ZONE 2 is active, the ZONE indicator appears in the left side of the FRONT PANEL DISPLAY.

NOTE: Zone 2 cannot be controlled from the remote in the main room.

To turn Zone 2 on or off:

1. Press the front-panel ZONE button. The status of Zone 2 appears in the display. If Zone 2 is in standby, "ZONE OFF" appears. If Zone 2 is active, "ZONE xxxx" showing the current input source appears.
2. If Zone 2 is ON, pressing the ZONE button a second time within 10 seconds turns it OFF. If Zone 2 is OFF, the second press of the ZONE button turns it ON with the last used input source and volume setting.
3. Following 10 seconds with no commands, the RSX-1065 reverts to normal operation.

To change the Zone 2 input source:

1. Press the front-panel ZONE button. The status of Zone 2 appears in the display. Make sure that Zone 2 is ON.
2. Within 10 seconds after pressing the ZONE button, press one of the INPUT SOURCE buttons to select a new source for Zone 2. The name of the selected source appears in the display.
3. Following 10 seconds with no commands, the RSX-1065 reverts to normal operation.

To change the Zone 2 volume:

1. Press the front-panel ZONE button. The status of Zone 2 appears in the display. Make sure that Zone 2 is ON.
2. Within 10 seconds after pressing the ZONE button, adjust the volume control to change the Zone 2 output level. The new setting appears in the display. This volume adjustment is only available using the VARIABLE output configuration. In FIXED output mode, the volume control for Zone 2 is disabled.
3. Following 10 seconds with no commands, the RSX-1065 reverts to normal operation.

Controlling Zone 2 from the Remote Location

With a properly configured IR repeater system, you have full control of Zone 2 using an RR-969 remote from the Zone 2 location. You can select and operate a source, adjust the volume, and turn Zone 2 on or off. Whatever commands you send from the RR-969 will change Zone 2 and only Zone 2, just as if you were controlling a totally independent audio system in that room. These changes will have no effect on the main listening room.

To turn Zone 2 on or off, press the POWER button **K** on the remote. To adjust the volume in Zone 2, press the VOLUME buttons **M** on the remote. To select a different analog input source, press one of the INPUT SOURCE buttons **F** on the remote.

When the TUNER source is not selected in the main room, you can also access the tuner functions (Preset, Tuning Up/Down, Direct Preset Channel Selection, etc.) from ZONE 2. This feature is not available when the TUNER source is active in the main room to avoid interrupting someone else's listening by changing the station.

Alternatively, you can control Zone 2 operations from a keypad installed in the remote zone and connected to the KEYPAD input on the RSX-1065 using standard RJ-45 8-pin modular plugs and wiring.

NOTE: The volume adjustment is only available if the Zone 2 outputs are configured to use VARIABLE levels. With FIXED levels, the volume control for Zone 2 is disabled.

Zone 2 Audio Outputs 45

See Figure 7

These line-level RCA outputs send the Zone 2 audio signal to a stereo amplifier driving a pair of speakers in the remote zone.

NOTE: Only analog input signals are available at the Zone 2 outputs. Source components connected to only the digital inputs are not available in Zone 2.

Although you have the option of using an integrated amplifier or a receiver to power the remote speakers, we suggest using a fixed-gain power amplifier. This simplifies system installation and operation. Your authorized Rotel dealer may make another recommendation based on specific system requirements.

To configure your system for Zone 2 operation, connect the left and right Zone 2 outputs on the RSX-1065 to the left and right channel inputs of the amplifier powering the remote speakers, using standard RCA audio cables.

NOTE: By default, the Zone 2 outputs provide a VARIABLE level signal, with control of the volume from the RSX-1065 front-panel and/or remote control from Zone 2. Alternatively, you can configure these outputs for FIXED level, which disables the volume control and sends a fixed line-level signal to an amplifier with its own volume control. See the ON-SCREEN DISPLAY/Configuration section for details.

ZONE REM IN Jack 28

See Figure 6

This 3.5 mm mini-jack accepts signals from a infrared repeater located in Zone 2. A third-party IR repeater system is required for operation of the RSX-1065's ZONE 2 functions from the remote zone.

NOTE: ZONE 2 and its IR repeater must be in a different location than RSX-1065 to prevent IR commands intended to control Zone 2 from inadvertently controlling the main room operations.

IR OUT Jacks 29

See Figure 6

The IR OUT 1 & 2 jacks send IR signals received at the ZONE REM IN jack or the EXTERNAL REM IN jack to an infrared emitter placed in front of a source component or to Rotel CD players, cassette decks, or tuners with a compatible rear panel IR connector.

This output is used to allow IR signals from Zone 2 to be sent to the source components, or to pass along IR signals from a remote in the main room when the sensors on the source components are blocked by installation in a cabinet. See your authorized Rotel dealer for information on IR repeater systems.

NOTE: The EXT REM IN jack located to the right of these jacks is for use with an external IR sensor duplicating the front-panel IR sensor and located in the primary zone. It should **not** be used for ZONE 2 IR connections.

On-Screen Display / Configuration

The RSX-1065 features two on-screen systems to help operate the system. The first consists of simple status displays that appear on the TV screen whenever primary settings (Volume, Input, etc.) are changed. These status displays are self-explanatory.

A more comprehensive ON-SCREEN DISPLAY menu system is available at any time by pressing the MENU button on the remote control. These menus guide you through the setup and operation of the RSX-1065.

System Set-Up: System setup should be done while using a Composite video or S-Video cable connecting the RSX-1065 TV MONITOR outputs to the video input of the TV or projector. No other video connections should be made at this time. Select OSD (ON-SCREEN MENU) from the RR-969 remote control to complete system setup.

NOTE: On a PAL standard monitor, the OSD cannot be displayed until a video signal is present, irrespective of the type of video cables in use. For setup, connect the Composite video output from your DVD player and select its input on the RSX-1065. The OSD will be displayed as an overlay to the video signal from the DVD player.

The ON-SCREEN MENU system can be configured to display one of two languages: English or German. If you would like to change from the default English language, see the instructions for the OTHER OPTIONS menu later in this manual.

Navigation Buttons

D P Q R

The following remote control buttons are used to navigate the ON-SCREEN DISPLAY menu system:

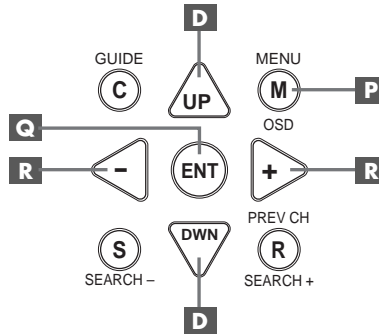

MENU Button P: To display the MAIN screen. All other menus are reached from this menu. If a menu is already visible, push this button to cancel the display.

DOWN/UP Buttons D: To move up and down in the lists that appear on the ON-SCREEN DISPLAY menu system.

+/- Buttons R: To change the current settings for a selected menu choice on some menus in the ON-SCREEN DISPLAY menu system.

ENTER Button Q: To confirm a setting and return to the MAIN menu.

NOTE: A help system at the bottom of each ON-SCREEN DISPLAY menu reminds you which buttons to press.

SYSTEM STATUS Menu

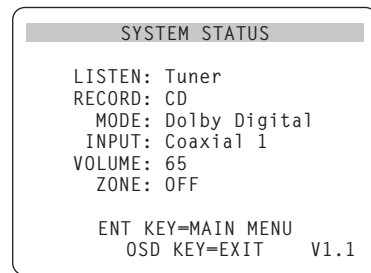

The SYSTEM STATUS menu provides a snapshot of the current system settings and a starting point for reaching all other screens and menus. This screen appears when you press the MENU button on the remote control and displays the following information:

LISTEN: the source selected for listening.

RECORD: the source selected for the VIDEO outputs.

MODE: the current surround sound mode.

INPUT: the input selected for the current source: Optical, Coaxial, Analog, etc.

VOLUME: the current volume setting.

ZONE: the current status of ZONE 2, ON or OFF.

VERSION: the version of the operating software currently installed in the RSX-1065.

No changes can be made using this screen; it only provides information. To go to the rest of the menus, press the ENTER button to go to the MAIN menu. Press the MENU key on the remote to cancel the display and return to normal operation.

NOTE: The SYSTEM STATUS screen appears for ten seconds when the unit is turned on and automatically turns off.

MAIN Menu

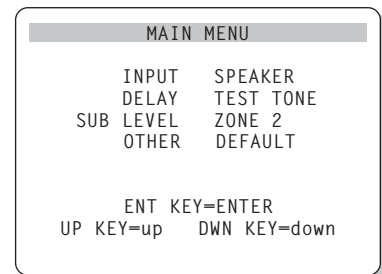

The MAIN menu provides access to eight other screens and menus and is reached by pressing the ENTER button from the SYSTEM STATUS menu described above or from most other menus. To go to another menu, move the highlight to the desired line using the UP/DOWN buttons on the remote and press the ENTER button. Press the MENU key on the remote to cancel the display and return to normal operation.

INPUT Menu

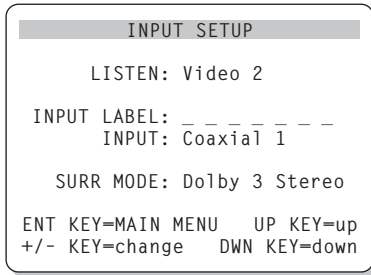

The INPUT menu configures the source inputs and is reached from the MAIN menu. The screen provides the following options, selected by placing the highlight on the desired line using the UP/DOWN buttons:

LISTEN: changes the current listening input source (CD, TUNER, TAPE, VIDEO1, VIDEO2, VIDEO3, VIDEO4, VIDEO5).

INPUT LABEL: The labels for the five VIDEO inputs can be customized (not available for the TUNER, CD, and TAPE inputs). Place the highlight on this line to call up a sub-menu that allows you to change the seven-character label for the current VIDEO source. To change the label:

1. Press the +/- keys to begin labeling.
2. Press the +/- keys to change the first letter, scrolling through the list of available characters.
3. Press the ENT key to confirm that letter and move to the next position.
4. Repeat steps 2 and 3 until all five characters have been completed. The final press of the ENT button will save the new label and exit the sub-menu.

INPUT: selects which physical input connection to use as the default for the source displayed in the first line of the menu. The options are ANALOG inputs, two OPTICAL digital inputs (OPTICAL 1 & 2), and three COAXIAL digital inputs (COAXIAL 1 – 3). When a digital input is selected, the unit will check for a digital signal when the INPUT SOURCE button is pressed. If no digital signal is present, the unit will automatically revert to the analog input. When an ANALOG input is selected, the unit will not access a digital signal, even though one may be present at the digital input; thus, the ANALOG setting forces the unit to use accept only an analog signal. Assigning a digital input (with its auto-sensing) is the preferred configuration for digital source inputs such as DVD players.

NOTE: *If a source connected to a digital input is selected, that signal will automatically be sent to both digital outputs for recording.*

SURR MODE: selects the default surround sound mode for the input shown at the top of the menu. The default setting will be used unless the source material triggers automatic decoding of a particular type or unless the default setting is overridden by the front panel or remote surround buttons. Options are: DTS, DTS-ES Matrix 6.1, DTS-ES Discrete 6.1, Dolby Digital, Dolby Pro Logic II, Dolby 3-Stereo, Music 1, Music 2, Music 3, Music 4, 5CH Stereo, 7CH Stereo, PCM 2-Channel, Dolby Digital 2-ch Stereo, HDCD, and Stereo.

This is a default setting for each input and, in some cases, can be manually overridden by the front-panel MODE buttons or the SUR+ button on the remote. See the SURROUND SOUND CONTROLS section of this manual for more information on which settings can be overridden.

NOTE: *We suggest that you return to this menu after connecting each source component to properly configure that source.*

To return to the MAIN menu, press the ENTER button. Press the MENU key on the remote to cancel the menu display and return to normal operation.

SPEAKER SETUP Menu

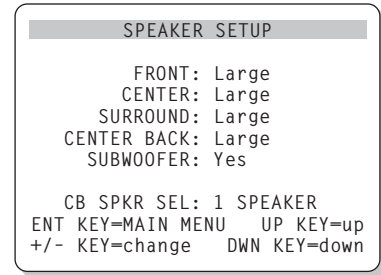

The SPEAKER SETUP menu is used to configure the RSX-1065 for use with your specific loudspeakers. The menu is accessed from the MAIN menu.

Home theater speaker systems vary in their size and performance, particularly in bass output. Surround sound processors feature steering logic which sends bass information to the speaker(s) best able to handle it – subwoofers and/or large speakers. For optimum performance, you must tell the RSX-1065 what types of speakers are in your system.

The following configuration instructions refer to LARGE and SMALL speakers, referring more to their bass performance than physical size. A full-range speaker with extended bass response is considered LARGE. A compact speaker with limited bass response or power handling is considered SMALL.

As a general rule, the system will redirect bass information away from SMALL speakers and send it to the LARGE speakers and/or the SUBWOOFER in your system.

Things become more complex with a subwoofer. For example, the system will generally not redirect bass information away from a LARGE speaker to the subwoofer. Thus, you must decide if you want a particular speaker to play the deep bass or whether the deep bass should be sent to the subwoofer. If you have a subwoofer, you might decide to send all of the bass to it, regardless of how capable the other speakers in the system may be. In this case, you would tell the RSX-1065 that all of your speakers are SMALL, without regard to how big they may actually be.

An alternative configuration for setting up front SMALL speakers with a subwoofer is to follow the speaker manufacturer's instructions, wiring the SMALL speakers to the subwoofer's crossover and then connecting the subwoofer directly to the front speaker connection terminals. In this arrangement, the speakers would be classified as LARGE and the subwoofer setting would be OFF for all surround modes. No information will be lost during playback because the system knows to redirect the bass information to the front LARGE speakers. This configuration may improve the way the bass integrates into the listening room and ensure correct satellite speaker operation by using the speaker manufacturer's own crossovers.

The following speaker options are available:

FRONT SPEAKERS (small/large): This menu setting determines what kind of main front left and right speakers you are using. Use the LARGE setting if your main left and right speakers are full range designs with good bass response capability. If you are using minispeakers, use the SMALL setting.

CENTER SPEAKER(S) (small/large/none): Use the LARGE position (not available with SMALL front speakers) if your system's center channel speaker is capable of full-range, extended bass response. Use the SMALL position if your center channel speaker has more limited low frequency capability, or if you prefer that the bass be sent to the subwoofer. Select the NONE setting if your system does not have a center channel speaker.

SURROUND SPEAKERS (small/large/none): If your surround speakers are capable of sustained low frequency output, select the LARGE setting (not available with SMALL front speakers). If your rear speakers have limited bass capability or if you would prefer that the bass go to a subwoofer, use the SMALL setting. If your system has no rear surround speakers, select the NONE setting (surround information will be added to the front speakers).

CENTER BACK SPEAKER(S) (small/large/none): Some systems have one or two additional center back surround speakers for use with 6.1 channel surround signals or 7CH stereo processing. With the RSX-1065, such a configuration is available using the preamp outputs and external amplifiers. If your center back speakers are capable of sustained low frequency output, select the LARGE setting (not available with SMALL front speakers). If your side speakers have limited bass capability or if you would prefer that the bass go to a subwoofer, use the SMALL setting. If your system has no center back speakers, select the NONE setting.

SUBWOOFER (yes/no/max): Use the YES setting if your system has a subwoofer. If your system does not have a subwoofer, select NO. Select the MAX setting to redirect all low frequency information from all speakers (including LARGE speakers) to the subwoofer.

CB SPKR SELECT (1 speaker/2 speakers): Use the 1 SPEAKER setting if your system has a single center back surround speaker. Use the 2 SPEAKERS setting if your system has 2 center back surround speakers. If your system does not have any center back speakers, select NONE on the previously described CENTER SPEAKER setting on this menu.

NOTE: *Speaker configuration is a global setting for all surround modes and need only be done once.*

To change a setting, place the highlight on the desired line using the UP/DOWN buttons and use the +/- buttons to toggle through the available settings. To return to the MAIN menu, press the ENTER button. Press the MENU key on the remote to cancel the display and return to normal operation.

DELAY SETUP Menu

DELAY SETUP		
	Dolby D	Dolby
	/DTS	Pro LogicII
CENTER:	01ms	
R SURROUND:	15ms	30ms
L SURROUND:	15ms	30ms
CNTR-BACK:	15ms	
ENT KEY=MAIN MENU UP KEY=up		
+/- KEY=change DWN KEY=down		

This menu, which is reached from the MAIN menu, allows you to set the delay for individual speakers. This ensures that the sound from each speaker arrives simultaneously at the listening position, even when the speakers are not all placed at equal distances from the listener.

Although personal preference is the ultimate guide, you typically increase the delay to speakers located closer to the seating area and decrease the delay to speakers located farther from the seating area.

Start by measuring the distance from your seating position to each speaker. The speaker farthest away should receive no additional delay. Each of the other speakers will receive one millisecond of delay for each foot (30 cm) closer to you than the farthest speaker. For example, if the left front speaker is farthest away at 13 feet and the left rear speaker is 8 feet away, you should add 5 milliseconds of delay to the left rear speaker. Continue setting delays for each speaker until you have compensated for each speaker that is closer to you than the farthest speaker.

The delay times for the surround speakers are set longer for Dolby Pro Logic II mode than in Dolby Digital/DTS mode. When you change delay setting for Dolby Digital/DTS, the delay time for Dolby Pro Logic II will automatically be set 15ms longer.

The available settings for the CENTER channel (Dolby Digital/DTS only) are 0ms, 1ms, 2ms, 3ms, 4ms, and 5ms. For SURROUND (Dolby Digital/DTS), the settings are 0ms, 5ms, 10ms, and 15ms. For SURROUND (Dolby Pro Logic II), the settings are 15ms, 20ms, 25ms, and 30ms. For the CENTER BACK channel (Dolby Digital/DTS only), the settings are 0ms, 5ms, 10ms, and 15ms.

To change a setting, place the highlight on the desired line using the UP/DOWN buttons and use the +/- buttons to increase or decrease

the delay setting. To return to the MAIN menu, press the ENTER button. Press the MENU key on the remote to cancel the display and return to normal operation.

SUBWOOFER SETUP Menu

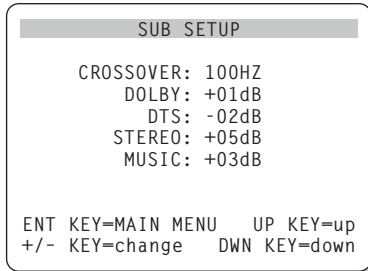

The SUBWOOFER SETUP menu allows selection of the subwoofer crossover frequency and independent adjustment of subwoofer level for each surround mode. These settings are memorized and engaged automatically each time a music or theater surround mode is selected.

When going to the SUBWOOFER SETUP menu from the MAIN menu, the current surround mode is automatically highlighted. Use the +/- buttons to adjust the subwoofer level (-10dB to +10dB) for the current surround mode.

NOTE: Only the current surround mode can be adjusted on this menu. You will need to change surround modes using the front-panel or remote buttons to adjust a different mode.

The CROSSOVER setting activates a low-pass filter for the subwoofer and a corresponding high-pass filter for all SMALL speakers in the system at the selected frequency. To adjust the crossover frequency, highlight the CROSSOVER line using the UP/DOWN buttons. Then, use the +/- buttons to choose one of the following options: OFF, 40Hz, 60Hz, 80 Hz, 100 Hz, or 120 Hz.

NOTE: The OFF setting sends a full-range signal to your subwoofer so that you can use its built-in low-pass filter. With the OFF setting, a 100 Hz high-pass filter is activated for all SMALL speakers in the system.

To return to the MAIN menu, press the ENTER button. Press the MENU key on the remote to cancel the display and return to normal operation.

TEST TONE Menu

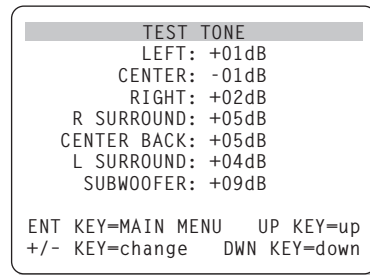

This menu uses test tones to set equal volume levels for all speakers (left front, center, right front, right surround, left surround, center back, and subwoofer) to ensure proper surround sound reproduction. Setting the output levels using the test procedure provides the most accurate adjustment so that digital surround sound material will be reproduced as it was intended.

NOTE: If you have configured your system to use two center back speakers, there will be an additional line in the menu, giving you the ability to independently adjust the CENTER BACK 1 and CENTER BACK 2 speakers.

To access this menu and perform the test tone calibration, you must be in one of the surround modes. To do this, press any of the MODE buttons except 2CH. Then, enter the ON-SCREEN DISPLAY menu system and select TEST TONE from the MAIN menu to reach this screen.

When you enter the TEST TONE menu, you will hear a test tone coming from the highlighted speaker. Highlight different speakers by moving the cursor to the desired line using the UP/DOWN buttons. The test tone will shift accordingly to the selected speaker.

While seated in the normal listening location, switch the test tone to the various speakers. Using the loudest speaker as a fixed reference, listen to hear if any other speakers are noticeably louder or quieter. If so, adjust that speaker's volume levels up or down (in 1dB increments) to match using the +/- buttons. Continue switching among the speakers and adjusting until all speakers are the same volume.

NOTE: This calibration will be more accurate using a sound pressure level (SPL) meter instead of relying on your ear. Set the meter to its SLOW response time with C-weighting and hold it away from your body. Adjust the levels until the meter provides the same reading for each of the speakers in your system.

To return to the MAIN menu, press the ENTER button. Press the MENU key on the remote to cancel the menu display and return to normal operation.

OTHER OPTIONS Menu

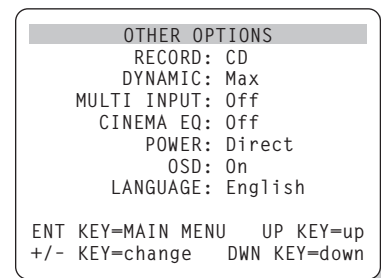

This menu, accessed from the MAIN menu, provides access to a several miscellaneous settings as follows:

RECORD: Select a signal for the record outputs by choosing one of the input sources.

DYNAMIC: steps through the three dynamic range settings available in digital modes:

- MAX (no compression/full dynamic range)
- MID (moderate compression)
- MIN (full compression/minimum dynamic range).

MULTI INPUT: determines whether the MULTI channel input is turned ON or OFF.

CINEMA EQ: determines a special equalization setting is turned ON or OFF. This equalization may be desirable for playback of movie source material to compensate for the acoustic differences between a commercial cinema and a home theater environment. The CINEMA EQ setting can also be changed using the FILTER button on the remote.

POWER: This setting determines how the RSX-1065 powers up. With the default DIRECT setting, the unit is fully activated when AC power is applied and the front-panel POWER button is pressed in; however, it may be put in STANDBY mode using the remote POWER button. With the STANDBY setting, the unit powers up in standby mode when AC is applied and the front-panel POWER button is in the ON position. The unit must be activated using the remote control POWER button. In ALWAYS-ON mode, the unit remains fully active whenever AC is present and the front-panel POWER button is pressed in; the remote POWER button is disabled and the unit cannot be put in standby mode.

OSD: Determines whether the ON-SCREEN DISPLAYS are shown on your TV monitor during operation.

LANGUAGE: Selects one of the two languages for all of the ON-SCREEN MENUS: English or German (Deutsch).

Change settings on the OTHER OPTIONS menu by highlighting the desired line using the UP/DOWN buttons and using the +/- buttons to step through the available settings. To return to the MAIN menu, press the ENTER button. Press the MENU key on the remote to cancel the display and return to normal operation.

DEFAULT SETUP Menu

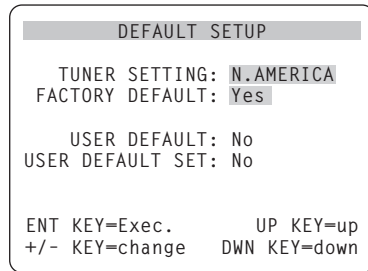
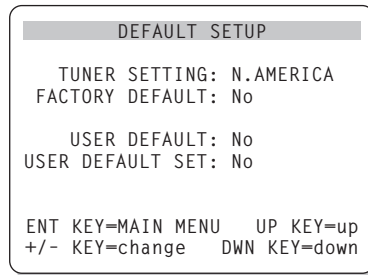

The DEFAULT SETUP menu provides access to four functions:

- Restoring all features and settings to the original FACTORY DEFAULT settings.
- Changing the tuning functions and displays for use in North America or Europe.
- Memorizing a custom group of settings as a USER DEFAULT.
- Activating the USER DEFAULT settings.

To restore the FACTORY DEFAULT settings: Place the highlight on the FACTORY DEFAULT line using the UP/DOWN buttons and use the +/- buttons to change the setting to YES. The screen will change to a confirmation screen. Press the ENTER button to proceed with resetting the FACTORY DEFAULT settings. The unit will power off and then on, with the factory settings restored. To return to the MAIN menu without resetting the FACTORY DEFAULT settings, change the entry to NO and press the ENTER button.

NOTE: Resetting to factory default settings will erase all stored settings including delay settings, speaker settings, balance settings, input settings and more. You will lose ALL system configuration settings. Be certain that you wish to do so before resetting the factory defaults.

To change the TUNER setting: Place the highlight on the TUNER SETTING line using the UP/DOWN buttons and use the +/- buttons to change the setting to N. AMERICA or

EUROPE. Then, move the highlight to the FACTORY DEFAULT line and change the setting to YES as described above. The screen will change to a confirmation screen. Press the ENTER button to proceed with resetting the FACTORY DEFAULT settings and changing the TUNER SETTING. To return to the MAIN menu without resetting the FACTORY DEFAULT and TUNER settings, change the entry to NO and press the ENTER button.

NOTE: Changing the default TUNER SETTING can only be done at the same time as restoring the FACTORY DEFAULT settings. Therefore, we recommend selecting your default TUNER SETTING and resetting to the FACTORY DEFAULT settings as the first step in configuring the unit, before you change or memorize any other configuration settings.

To save USER DEFAULT settings: Many of the current configuration settings can be stored as a USER DEFAULT, which can be activated at any time from this menu screen. To save the current settings as a USER DEFAULT Place the highlight on the USER DEFAULT SET line using the UP/DOWN buttons and use the +/- buttons to change the setting to YES. The screen will change to a confirmation screen. Press the ENTER button to store the new USER DEFAULT settings. To return to the MAIN menu without saving any changes, change all entries on the screen to NO and press the ENTER button.

NOTE: If there is insufficient memory to store a USER DEFAULT configuration file, the USER DEFAULT SET option will not be available.

To activate memorized USER DEFAULT settings: After you have stored a USER DEFAULT configuration file, you can activate those settings at any time by placing the highlight on the USER DEFAULT line using the UP/DOWN buttons. Use the +/- buttons to change the setting to YES. The screen will change to a confirmation screen. Press the ENTER button to proceed with activating the USER DEFAULT settings. To return to the MAIN menu without activating the USER DEFAULT settings, change the entry to NO and press the ENTER button.

ZONE 2 SETUP Menu

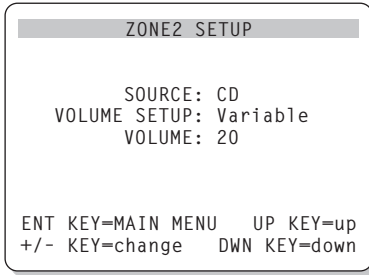

The ZONE 2 SETUP menu provides settings and configuration options related to the operation of Zone 2. This menu is reached by highlighting the ZONE 2 line on the MAIN menu and pressing ENTER.

SOURCE: the source selected for listening in Zone 2. Selecting the OFF option turns Zone 2 off.

VOLUME SETUP: configures the Zone 2 outputs for VARIABLE or FIXED volume levels. VARIABLE allows control of the volume settings in Zone 2 from the RSX-1065 front-panel or from a remote control/IR repeater or keypad in Zone 2. FIXED output disables the Zone 2 volume control. In this mode, the Zone 2 level can be fixed at the level specified on the next line, thus optimizing system performance when sending a fixed level signal to a preamp or amplifier with its own volume adjustment.

VOLUME: In VARIABLE output mode, this line shows the current volume setting for Zone 2. In FIXED output mode, this volume setting establishes a permanent fixed output level for Zone 2.

Move the highlight to the desired line using the UP/DOWN buttons and use the +/- buttons to adjust the volume level. To return to the MAIN menu, press the ENTER button. Press the MENU key on the remote to cancel the display and return to normal operation.

Specifications

Audio

Continuous Amplifier Power (five channels driven)

100 watts/ch (20-20k Hz, <0.05% THD, 8 ohms)

Continuous Amplifier Power (two channels driven)

120 watts/ch (1kHz, <1.0% THD, 8 ohms, DIN)

Total Harmonic Distortion

<0.05%

Intermodulation Distortion (60 Hz:7 kHz)

<0.05%

Frequency Response

10 Hz - 95 kHz, ± 1 dB (line level)

10 Hz - 20 kHz, ± 0.3 dB (digital level)

Signal to Noise Ratio (IHF A-weighted)

95 dB (Stereo) Analog

92 dB (Dolby Digital, dts) 0dBfs

Input Sensitivity/Impedance

Line Level: 200 mV/47 kohms

Tone Controls (Bass/Treble)

± 8 dB at 100 Hz/10 kHz

Preamp Output Level

1.2 V (200 mV Input)

Video

Frequency Response

3 Hz - 10 MHz, ± 3 dB

Signal to Noise Ratio

45 dB

Input Impedance

75 ohms

Output Impedance

75 ohms

Output Level

1 volt

FM Tuner

Usable Sensitivity

14.2 dBf

Signal to Noise Ratio (at 65 dBf)

70 dBf

Harmonic Distortion (at 65 dBf)

0.03%

Stereo Separation (1 kHz)

45 dB

Output level

1 V

Antenna Input

75 ohms unbalanced

AM Tuner

Sensitivity

500 μ V/m

Signal to Noise Ratio

40 dBf

Output level

500 mV

Antenna Input

Loop Antenna

General

Power Consumption:

550 watts

Power Requirements (AC)

115 volts, 60Hz (USA version)

230 volts, 50Hz (CE version)

Weight

20.4 Kg/44.9 lb.

Dimensions (W x H x D)

432 x 189 x 427 mm

17" x 7 1/2" x 16 7/8"

Front Panel Height

(feet removed/for rack mount)

176 mm / 7"

All specifications are accurate at the time of printing.

Rotel reserves the right to make improvements without notice.

Rotel and the Rotel HiFi logo are registered trademarks of The Rotel Co, Ltd., Tokyo, Japan.



ROTEL

The Rotel Co. Ltd.

10-10 Shinsen-Cho
Shibuya-Ku
Tokyo 150-0045
Japan
Phone: +81 3-5458-5325
Fax: +81 3-5458-5310

Rotel of America

54 Concord Street
North Reading, MA 01864-2699
USA
Phone: +1 978-664-3820
Fax: +1 978-664-4109

Rotel Europe

Meadow Road
Worthing, West Sussex BN11 2RX
England
Phone: +44 (0)1903 524 813
Fax: +44 (0)1903 524 831

Rotel Deutschland

Kleine Heide 12
D-33790 Halle/Westf.
Germany
Phone: +49 05201-87170
Fax: +49 05201-73370

www.rotel.com